

# Trimble T10x tablet (2024)

USER GUIDE

Model: Y302-01  
Version 1.00  
Revision B  
March 2024



# Legal Notices

trimble.com

## Global technical support

To request detailed technical assistance for Trimble solutions, contact [trimble\\_support@trimble.com](mailto:trimble_support@trimble.com).

## Copyright and trademarks

© 2024, Trimble Inc. All rights reserved.

Trimble and the Globe & Triangle logo are trademarks of Trimble Inc., registered in the United States and in other countries.

Microsoft and Windows are either registered trademarks or trademarks of Microsoft Corporation in the United States and/or other countries.

The Bluetooth word mark and logos are owned by the Bluetooth SIG, Inc. and any use of such marks by Trimble Inc. is under license.

All other trademarks are the property of their respective owners.

## Release Notice

This is the March 2024 release (Revision B) of the Trimble T10x tablet (2024) documentation.

## Recycling information

You should dispose of the device and accessories properly according to local laws and regulations. Because the device contains electronic components, it must be disposed of separately from household waste. When the device reaches its end of life, contact your local Trimble dealer to learn about disposal and recycling options for your area.

### Recycling in Europe



The symbol above means that according to local laws and regulations your product and/or its battery shall be disposed of separately from household waste. When this product reaches its end of life, take it to a collection point designated by local authorities. The separate collection and recycling of your product and/or its battery at the time of disposal will help conserve natural resources and ensure that it is recycled in a manner that protects human health and the environment.

For information about recycling Trimble WEEE (Waste Electrical and Electronic Equipment) products that run on electrical power go to <https://www.trimble.com/en/our-commitment/responsible-business/product-compliance/environmental-compliance>.

The ERFC Netherlands will recycle on behalf of Trimble Distributors, conforming to the European Union's WEEE Directive 2002/96/EC, any WEEE supplied to the market by Trimble Inc., their partners and/or subsidiaries.

### Taiwan – Battery Recycling Requirements



The product contains a Lithium-ion battery. Taiwanese regulations require that waste batteries are recycled.

廢電池請回收

**CAUTION** – RISK OF EXPLOSION IF BATTERY IS REPLACED BY AN INCORRECT TYPE.

DISPOSE OF USED BATTERIES ACCORDING TO THE INSTRUCTIONS.

Product Antenna and Gain - Table 1

List of antenna information				Gain	
Components	Frequency (MHz)	Antenna type	Brand	Main	Aux.
WLAN	2412-2484	PIFA	Anjie	1.9 dBi	-0.8 dBi
	5150-5850	PIFA	Anjie	2.9 dBi	2.50 dBi
Bluetooth	2402-3480	PIFA	Anjie	1.9 dBi	N/A

Regional compliance

Australia and New Zealand



This product conforms with the regulatory requirements of the Australian Communications and Media Authority (ACMA) Telecommunications, Radiocommunications and EMC Labelling Notices, thus satisfying the requirements for RCM marking and sale within Australia and New Zealand.

Europe

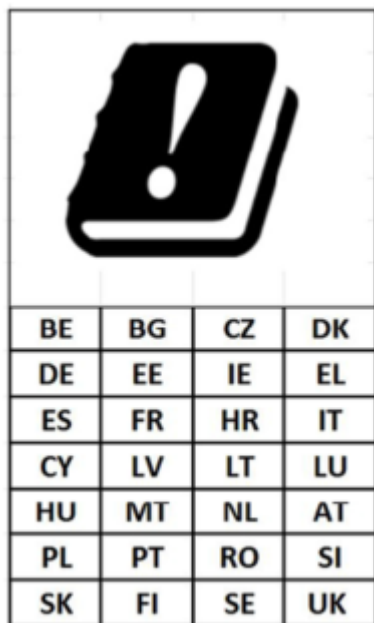

This Trimble product has been tested and found to comply with all requirements for CE Marking and sale within the European Economic Area (EEA). The device has Bluetooth and wireless LAN approval and satisfies the requirements for . These requirements provide reasonable protection against harmful interference when the equipment is operated appropriately in a residential or commercial environment.

A minimum separation distance of 20 cm must be maintained between the user's body and the device.

**Frequency bands and Powers**

- a. Frequency band(s) in which the radio equipment operates; see [Product Antenna and Gain - Table 1](#)
- b. Maximum radio-frequency power transmitted in the frequency band(s) in which the radio equipment operates: see [Product Antenna and Gain - Table 1](#)

**Components and accessories**

Only use approved accessories and components including software which allow the radio equipment to operate as intended.

Manufacturers only have to describe those accessories and components including software if they:

- have an influence on the conformity of the radio equipment, and
- are intended to be installed or changed by the user without the control of the manufacturer.

The instructions shall also include information required as above.

**Operating temperature:** -10 °C to +60 °C (+14 °F to +140 °F)

**Charging Temperature:** 0 °C to +45 °C (+32 °F to +113 °F)

### European declaration of conformity

Manufacturer's Name: Trimble Inc.

Manufacturer's Address: 4450 Gibson Dr, Tipp City, OH 45371, USA

Trimble declares, under our sole responsibility, that the product:

Product Name: T10x tablet (2024)

Model Number: Y302-01

In all cases assessment of the final product must be compliance with the Essential Requirements of the RED Directive 2014/53/EU Articles 3.1(a) and (b), safety and EMC respectively, as well as any relevant Article 3.2 requirements. An up-to-date DoC is available upon request.

### Importer of Record

Trimble European Regional Fulfillment Center  
Logistics Manager  
Trimble Europe B.V. & Trimble International B.V.  
Industrieweg 187a  
5683 CC Best  
The Netherlands

### Trimble EC

Trimble Germany  
Am Prime Parc 11  
65479 Raunheim  
Germany

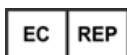

**CAUTION** - Only approved accessories may be used with this equipment. In general, all cables must be high quality, shielded, correctly terminated and normally restricted to two meters in length. Power supplies approved for this product employ special provisions to avoid radio interference and should not be altered or substituted. Unapproved modifications or operations beyond or in conflict with these instructions for use may void authorization by the authorities to operate the equipment.

### Canada

**IC ID:**7647A-600AX210NG

### Product Antenna and Gain

RSS-GEN section 8.3

This radio transmitter has been approved by Industry Canada to operate with supplied internal antenna with the maximum permissible gain indicated. Any other antenna types are strictly prohibited for use with this device.

Cet émetteur radio a été approuvé par l'Industrie Canada pour fonctionner avec l'antenne interne fournie avec le gain maximum admissible indiqué. Il est strictement interdit d'utiliser tout autre type d'antenne avec cet appareil.

See [Product Antenna and Gain - Table 1, page 3](#)

### Industry Canada statement

- 1 This device complies with Industry Canada license-exempt RSS standard(s). Operation is subject to the following two conditions: 1) this device may not cause interference, and 2) this device must accept any interference, including interference that may cause undesired operation of the device.

Le présent appareil est conforme aux CNR d'Industrie Canada applicables aux appareils radio exempts de licence. L'exploitation est autorisée aux deux conditions suivantes: 1) l'appareil ne doit pas produire de brouillage, et 2) l'utilisateur de l'appareil doit accepter tout brouillage radioélectrique subi, même si le brouillage est susceptible d'en compromettre le fonctionnement.

- 2 This Class B digital apparatus complies with Canadian ICES-003

Cet appareil numérique de la classe B est conforme à la norme NMB-003 du Canada.

- 3 This device complies with RSS-310 of Industry Canada. Operation is subject to the condition that this device does not cause harmful interference

Cet appareil est conforme à la norme RSS-310 d'Industrie Canada. L'opération est soumise à la condition que cet appareil ne provoque aucune interférence nuisible

- 4 This device and its antenna(s) must not be co-located or operating in conjunction with any other antenna or transmitter, except tested built-in radios

Cet appareil et son antenne ne doivent pas être situés ou fonctionner en conjonction avec une autre antenne ou un autre émetteur, exception faites des radios intégrées qui ont été testées.

- 5 The County Code Selection feature is disabled for products marketed in the U.S./ Canada.

La fonction de sélection de l'indicatif du pays est désactivée pour les produits commercialisés aux États-Unis et au Canada.

#### FOR PORTABLE DEVICE (<20 cm from body / SAR needed)

**Radiation Exposure Statement:** The product complies with the Canada portable RF exposure limit set forth for an uncontrolled environment and is safe for intended operation as described in this manual. Further RF exposure reduction can be achieved if the product can be kept as far as possible from the user's body, or set the device to lower output power if such a function is available.

**For devices that SAR tested with distance:** This device has been tested for compliance with IC SAR values at a typical operating near the body. To ensure that RF exposure levels below the levels tested, use accessories with this equipment to maintain a minimum separation distance of 20 cm between the body of the user and the device. These accessories should not contain metallic components. It is possible that accessories used close to the body that do not meet these requirements are not consistent with the SAR limits and it is advisable to avoid using them.

**Déclaration d'exposition aux radiations:** Le produit est conforme aux limites d'exposition pour les appareils portables RF pour les États-Unis et le Canada établies pour un environnement non contrôlé. Le produit est sûr pour un fonctionnement tel que décrit dans ce manuel. La réduction aux expositions RF peut être augmentée si l'appareil peut être conservé aussi loin que possible du corps de l'utilisateur ou que le dispositif est réglé sur la puissance de sortie la plus faible si une telle fonction est disponible.

**Pour les appareils testés par SAR à distance:** Ce dispositif a été testé pour la conformité avec les valeurs SAR à un fonctionnement typique près du corps. Pour assurer que les niveaux d'exposition aux radiofréquences en deçà des niveaux testés, utiliser des accessoires avec cet équipement pour maintenir une distance de séparation minimale de 20 cm entre le corps de l'utilisateur et l'appareil. Ces accessoires ne doivent pas contenir des composants métalliques. Il est possible que les accessoires utilisés près du corps qui ne répondent pas à ces exigences ne sont pas compatibles avec les limites SAR et il est conseillé d'éviter de les utiliser.

#### FOR WLAN 5 GHZ DEVICE:

**CAUTION:** The device for operation in the band 5150-5250 MHz is only for indoor use to reduce the potential for harmful interference to co-channel mobile satellite systems.

**AVERTISSEMENT:** Les dispositifs fonctionnant dans la bande de 5 150 à 5 250 MHz sont réservés uniquement pour une utilisation à l'intérieur afin de réduire les risques de brouillage préjudiciable aux systèmes de satellites mobiles utilisant les mêmes canaux.

#### U.S.

**FCC ID:** YE3600-AX210NG

#### Federal Communication Commission (FCC) Interference Compliance Statement

This equipment has been tested and found to comply with the limits for a Class B digital device pursuant to Part 15 of the FCC Rules. These limits are designed to provide reasonable protection against harmful interference in a residential installation. Operation is subject to the following two conditions: (1) this device may not cause harmful interference, and (2) this device must accept any interference received, including interference that may cause undesired operation.

This equipment generates, uses, and can radiate radio frequency energy and, if not installed and used in accordance with the instructions may cause harmful interference to radio communication. However, there is no guarantee that interference will not occur in a particular installation. If this equipment does cause harmful interference to radio or television reception, which can be determined by turning the equipment off and on, the user is encouraged to try to correct the interference by one or more of the following measures:

- Reorient or relocate the receiving antenna.
- Increase the separation between the equipment and the receiver.
- Connect the equipment into an outlet on a circuit different from that to which the receiver is connected.
- Consult the dealer or an experienced radio/TV technician for help.

Changes and modifications not expressly approved by the manufacturer or registrant of this equipment can void your authority to operate this equipment under Federal Communications Commission rules.

## Brazil

Este equipamento não tem direito à proteção contra interferência prejudicial e não pode causar interferência em sistemas devidamente autorizados.



## Limited Warranty Terms and Conditions

### Product Limited Warranty

Subject to the terms and conditions set forth herein, Trimble Inc. ("Trimble") warrants that for a period of two (2) years from date of purchase this Trimble product (the "Product") will substantially conform to Trimble's publicly available specifications for the Product and that the hardware and any storage media components of the Product will be substantially free from defects in materials and workmanship.

### Product Software

Product software, whether built into hardware circuitry as firmware, provided as a standalone computer software product, embedded in flash memory, or stored on magnetic or other media, is licensed solely for use with or as an integral part of the Product and is not sold. The terms of the end user license agreement, as included below, govern the use of the Product Software, including any differing limited warranty terms, exclusions and limitations, which shall control over the terms and conditions set forth in the limited Product warranty.

### Warranty Remedies

If the Trimble Product fails during the warranty period for reasons covered by this limited warranty and you notify Trimble of such failure during the warranty period, Trimble will repair OR replace the nonconforming Product with new, equivalent to new, or reconditioned parts or Product, OR refund the Product purchase price paid by you, at Trimble's option, upon your return of the Product in accordance with Trimble's product return procedures then in effect.

### How to Obtain Warranty Service

To obtain warranty service for the Product, it is recommended you contact your Trimble dealer. Alternatively, you may contact Trimble to request warranty service by emailing [Repair\\_Services@Trimble.com](mailto:Repair_Services@Trimble.com). Please be prepared to provide:

- your name, address, and telephone numbers;
- product name, part number and serial number;
- proof of purchase;
- an explanation of the problem.

The customer service representative may need additional information from you depending on the nature of the problem.

### Warranty Exclusions and Disclaimer

This Product limited warranty shall only apply in the event and to the extent that (i) the Product is properly and correctly installed, configured, interfaced, maintained, stored, and operated in accordance with Trimble's applicable operator's manual and specifications, and; (ii) the Product is not modified or misused. This Product limited warranty shall not apply to, and Trimble shall not be responsible for, defects or performance problems resulting from (i) the combination or utilization of the Product with hardware or software products, information, data, systems, interfaces, or devices not made, supplied, or specified by Trimble; (ii) the operation of the Product under any specification other than, or in addition to, Trimble's standard specifications for its products; (iii) the unauthorized installation, modification, or use of the Product; (iv) damage caused by: accident, lightning or other electrical discharge, fresh or salt water immersion or spray (outside of Product specifications); or exposure to environmental conditions for which the Product is not intended; (v) normal wear and tear on consumable parts (e.g., batteries); or (vi) cosmetic damage. Trimble does not warrant or guarantee the results obtained through the use of the Product or Software, or that software components will operate error free.

NOTICE REGARDING PRODUCTS EQUIPPED WITH TECHNOLOGY CAPABLE OF TRACKING SATELLITE SIGNALS FROM SATELLITE BASED AUGMENTATION SYSTEMS (SBAS) (WAAS, EGNOS, GAGAN, MSAS AND LUCH), OMNISTAR, BEIDOU, GPS, GALILEO OR GLONASS SATELLITES, OR FROM IALA BEACON SOURCES: TRIMBLE IS NOT RESPONSIBLE FOR THE OPERATION OR FAILURE OF OPERATION OF ANY SATELLITE BASED POSITIONING SYSTEM OR THE AVAILABILITY OF ANY SATELLITE BASED POSITIONING SIGNALS.

THE FOREGOING LIMITED WARRANTY TERMS STATE TRIMBLE'S ENTIRE LIABILITY, AND YOUR EXCLUSIVE REMEDIES, RELATING TO THE TRIMBLE PRODUCT. EXCEPT AS OTHERWISE EXPRESSLY PROVIDED HEREIN, THE PRODUCT, AND ACCOMPANYING DOCUMENTATION AND MATERIALS ARE PROVIDED "AS-IS" AND WITHOUT EXPRESS OR IMPLIED WARRANTY OF ANY KIND, BY EITHER TRIMBLE OR ANYONE WHO HAS BEEN INVOLVED IN ITS CREATION, PRODUCTION, INSTALLATION, OR DISTRIBUTION, INCLUDING, BUT NOT LIMITED TO, THE IMPLIED WARRANTIES OF MERCHANTABILITY AND FITNESS FOR A PARTICULAR PURPOSE,

TITLE, AND NONINFRINGEMENT. THE STATED EXPRESS WARRANTIES ARE IN LIEU OF ALL OBLIGATIONS OR LIABILITIES ON THE PART OF TRIMBLE ARISING OUT OF, OR IN CONNECTION WITH, ANY PRODUCT. BECAUSE SOME STATES AND JURISDICTIONS DO NOT ALLOW LIMITATIONS ON DURATION OR THE EXCLUSION OF AN IMPLIED WARRANTY, THE ABOVE LIMITATION MAY NOT APPLY TO YOU.

#### Limitation of Liability

TRIMBLE'S ENTIRE LIABILITY UNDER ANY PROVISION HEREIN SHALL BE LIMITED TO THE AMOUNT PAID BY YOU FOR THE PRODUCT. TO THE MAXIMUM EXTENT PERMITTED BY APPLICABLE LAW, IN NO EVENT SHALL TRIMBLE OR ITS SUPPLIERS BE LIABLE FOR ANY INDIRECT, SPECIAL, INCIDENTAL, OR CONSEQUENTIAL DAMAGE WHATSOEVER UNDER ANY CIRCUMSTANCE OR LEGAL THEORY RELATING IN ANYWAY TO THE PRODUCTS, SOFTWARE AND ACCOMPANYING DOCUMENTATION AND MATERIALS, (INCLUDING, WITHOUT LIMITATION, DAMAGES FOR LOSS OF BUSINESS PROFITS, BUSINESS INTERRUPTION, LOSS OF DATA, OR ANY OTHER PECUNIARY LOSS), REGARDLESS OF WHETHER TRIMBLE HAS BEEN ADVISED OF THE POSSIBILITY OF ANY SUCH LOSS AND REGARDLESS OF THE COURSE OF DEALING WHICH DEVELOPS OR HAS DEVELOPED BETWEEN YOU AND TRIMBLE. BECAUSE SOME STATES AND JURISDICTIONS DO NOT ALLOW THE EXCLUSION OR LIMITATION OF LIABILITY FOR CONSEQUENTIAL OR INCIDENTAL DAMAGES, THE ABOVE LIMITATION MAY NOT APPLY TO YOU.

NOTE: THE ABOVE TRIMBLE LIMITED WARRANTY PROVISIONS WILL NOT APPLY TO PRODUCTS PURCHASED IN THOSE JURISDICTIONS (E.G., MEMBER STATES OF THE EUROPEAN ECONOMIC AREA) IN WHICH PRODUCT WARRANTIES ARE THE RESPONSIBILITY OF THE LOCAL DEALER FROM WHOM THE PRODUCTS ARE ACQUIRED. IN SUCH A CASE, PLEASE CONTACT YOUR TRIMBLE DEALER FOR APPLICABLE WARRANTY INFORMATION.

#### Notice to Australian Purchasers - The Australian Consumer Law

Our goods come with guarantees that cannot be excluded under the Australian Consumer Law. You are entitled to a replacement or refund for a major failure and for compensation for any other reasonably foreseeable loss or damage. You are also entitled to have the goods repaired or replaced if the goods fail to be of acceptable quality and the failure does not amount to a major failure.

Trimble's warranty, as set out in the user manual accompanying this statement, or as described in the warranty card accompanying the Product you purchased, is in addition to any mandatory rights and remedies that you may have under the Australian Consumer Law.

#### Official Language

THE OFFICIAL LANGUAGE OF THESE TERMS AND CONDITIONS IS ENGLISH. IN THE EVENT OF A CONFLICT BETWEEN ENGLISH AND OTHER LANGUAGE VERSIONS, THE ENGLISH LANGUAGE SHALL CONTROL

# Contents

<b>Legal Notices</b>	<b>2</b>
<b>Contents</b>	<b>8</b>
<b>Safety information</b>	<b>11</b>
Safety notices	11
Battery safety	11
Power supply safety	12
Touchscreen glass	12
Service safety	12
Safe environments of use	12
Hearing damage	13
Distraction	13
Telecommunications & Internet Association (TIA)	13
Specific Absorption Rate (SAR)	13
Caring for your device	13
Cleaning	13
Touchscreen care	14
Battery care	14
Product specifications	16
<b>Introduction</b>	<b>17</b>
Registration	17
In the box	17
Replacement and spare or optional accessories	18
Parts of the T10x tablet (2024)	19
<b>Basic setup and operation</b>	<b>20</b>
Charging and power modes	20
Charging the battery	21
Checking the battery charge level	21
LED charging status	21
Using the Power button	21
Saving battery power	22
Wake and unlock	22
Restart the device	22
Turning off the device	22
Power options	22
Sleep state	23
Making your battery last longer	23
Removing and inserting battery packs	24
Installing a screen protector	24
Using the touchscreen	25
Main touchscreen input gestures and functions supported on the T10x tablet (2024)	25
Using the onscreen keypad	26



Using Trimble software that provides a keypad .....	26
Using a USB or Bluetooth mouse and keyboard .....	27
Using the Digital Pen .....	27
Replacing the battery .....	27
Turning the Digital Pen on / off .....	28
Using the Pen Clip to tether the Digital Pen .....	28
Caring for the Digital Pen .....	28
Using the programmable keys (Button Manager) .....	28
Accessing the Button Manager from Windows Desktop .....	29
Assigning a function to a button .....	30
Using the Control Center utility .....	32
Accessing the Control Center from the Windows Desktop .....	32
Module function settings .....	33
<b>Using the Windows operating system .....</b>	<b>36</b>
Using accounts .....	36
Sign in .....	36
Sign out .....	37
Using the Start menu .....	37
Using the Action Center .....	37
Using the Windows Mobility Center .....	37
Using Task View and virtual desktops .....	38
Settings .....	38
Display settings: adjusting the backlight .....	39
Display settings: rotation lock .....	39
<b>Using wireless networks .....</b>	<b>41</b>
Airplane mode .....	41
Working with Wi-Fi networks .....	41
Connecting to Wi-Fi .....	41
Disconnecting from a Wi-Fi network .....	42
Forgetting a Wi-Fi network .....	42
<b>Using accessories and connecting to other devices .....</b>	<b>43</b>
Connecting to USB accessories .....	43
Connecting to Bluetooth accessories .....	43
<b>Using the camera .....</b>	<b>45</b>
Taking photos and videos .....	45
Changing camera settings .....	45
Enable the Camera app to access your location to geo-tag photos .....	46
Viewing photos and videos .....	46
<b>Using the pre-installed apps .....</b>	<b>48</b>
Bundled Microsoft apps .....	48
Getting more apps .....	48

<b>Troubleshooting</b> .....	<b>49</b>
Further assistance and support with the Windows 11 IoT Enterprise operating system .....	49
Performance issues .....	49
Device is running slowly .....	49
Wireless connectivity issues .....	50
Wi-Fi speed is slow .....	50
Wi-Fi is not connected .....	50
Power and battery issues .....	51
Battery will not charge .....	51
Device will not start up .....	51
Device suddenly turns off during use .....	51
Device shuts down when hot-swapping the battery .....	51
Restarting or resetting the operating system .....	52
Restarting your (unresponsive) device .....	52
Resetting your device .....	52
Resetting your device when the operating system is unresponsive .....	53
Operating system and software updates .....	53
Windows 11 updates .....	53
Software downloads and updates .....	53
Repairing your device .....	54

# Safety information

Read this guide for important safety and health information and the terms of the Limited Warranty that apply to the Trimble® T10x Tablet (2024) that you have purchased. Failure to follow instructions and properly set up, use, and care for this product can increase the risk of serious injury or death, or damage the device or devices.

- [Safety notices, page 11](#)
- [Power supply safety, page 12](#)
- [Touchscreen glass, page 12](#)
- [Service safety, page 12](#)
- [Safe environments of use, page 12](#)
- [Hearing damage, page 13](#)
- [Distraction, page 13](#)
- [Telecommunications & Internet Association \(TIA\), page 13](#)
- [Specific Absorption Rate \(SAR\), page 13](#)
- [Caring for your device, page 13](#)

## Safety notices

### Battery safety

Lithium-Ion batteries are classified by the U. S. Federal Government as non-hazardous waste and are safe for disposal in the normal municipal waste stream. These batteries contain recyclable materials and are accepted for recycling. Dispose of used batteries in accordance with local regulations.

**WARNING** – Non-approved batteries will not function in the device. Use only the battery for the system for which it was specified. Only use the battery with a charging system that has been qualified with the system per this standard. Use of an unqualified battery or charger may present a risk of fire, explosion, leakage, or other hazard.

**WARNING** – There are no user-serviceable parts in the batteries. Do not disassemble or open, crush, bend or deform, puncture, or shred the battery. Do not modify or remanufacture, attempt to insert foreign objects into the battery, immerse or expose to water or other liquids, or expose to fire, explosion, or other hazard. Do not expose to temperatures above +70 °C (+158 °F).

**WARNING** – Improper battery use may result in a fire, explosion, or other hazard.

- Do not short circuit a battery or allow metallic or conductive objects to contact the battery terminals.
- Avoid dropping the device or battery. If dropped, especially on a hard surface, and the user suspects damage to the battery, take it to a service center for inspection.
- In the event of a battery leak, do not allow the liquid to come in contact with the skin or eyes. If contact has been made, wash the affected area with large amounts of water and seek medical advice.
- Battery usage by children should be supervised.

## Power supply safety

**WARNING** – Use only AC and vehicle adapters intended for the device. Other external power sources may damage your product and void the warranty.

- Ensure the input voltage on the adapter matches the voltage in your location. Ensure the adapter has prongs compatible with your outlets.
- The AC power supply is designed for indoor use only. Avoid using the AC power supply in wet areas.
- Unplug the power supply from power when not in use.
- Do not short the output connector.

## Touchscreen glass

**CAUTION** – The touchscreen on this device is made of glass. This glass could break if the device is dropped on a hard surface or receives a significant impact. If the glass chips or cracks, do not touch or attempt to remove the broken glass. Cracked or chipped glass due to misuse or abuse is not covered under the product's limited warranty.

## Service safety

**WARNING** – Do not attempt to take apart, open, service, or modify the product, accessories, or power supply. Doing so could present the risk of electric shock or other hazard. Any evidence of any attempt to open and/or modify this device, including any peeling, puncturing, or removal of any of the labels, will void the Limited Warranty.

## Safe environments of use

**WARNING** – Areas with potentially explosive atmospheres are often, but not always, posted and can include fueling areas, such as below decks on boats, fuel or chemical transfer or storage facilities, or areas where the air contains chemicals or particles, such as grain dust, or metal powders. When you are in such an area, turn off your mobile device, and do not remove or install battery chargers, AC adapters, or any other accessory. In such areas, sparks can occur and cause an explosion or fire.

## Hearing damage

**WARNING** – To prevent possible hearing damage, do not listen to high volumes for long periods.

## Distraction

**WARNING** – Using the device in some circumstances can distract you and may cause a dangerous situation. Observe rules that prohibit or restrict the use of mobile devices (for example, avoid operating the device while driving a vehicle).

## Telecommunications & Internet Association (TIA)

**Hearing Aids:** Some digital wireless devices may interfere with some hearing aids. In the event of such interference, you may want to consult your service provider, or call the customer service line to discuss alternatives.

**Pacemakers and Other Medical Devices:** The Health Industry Manufacturers Association recommends a minimum separation of six inches be maintained between a handheld wireless device and a pacemaker to avoid potential interference with the pacemaker. These recommendations are consistent with the independent research by and recommendations of Wireless Technology Research. Persons with pacemakers should use the ear opposite the pacemaker to minimize the potential for interference. If you have any reason to suspect that interference is taking place, turn the device OFF immediately.

If you use any other personal medical device, consult the manufacturer of your device to determine if they are adequately shielded from external RF energy. Your physician may be able to assist you in obtaining this information.

Turn the device OFF in health care facilities when any regulations posted in these areas instruct you to do so. Hospitals or health care facilities may be using equipment that could be sensitive to external RF energy.

## Specific Absorption Rate (SAR)

This device complies with FCC and CE standards when used as designed.

## Caring for your device

### Cleaning

Turn off the device, and disconnect it from external power. Use a soft, dampened cloth with either water or a diluted mild detergent. If a mild detergent is used, ensure all soap residue is removed. Do not use chemical cleaners.

## Touchscreen care

The T10x tablet (2024) is extremely rugged, is rated IP65, and is designed to withstand extreme conditions and harsh treatment, however taking proper care of the touchscreen will prolong the life and ensure optimal display performance of the touchscreen of this product. Excessive or prolonged exposure to abrasives, oil, dust, chemicals, and ultraviolet light can affect the performance of your touchscreen over time.

To help protect the screen:

- **Clean it frequently.** Use a soft, lint-free cloth to wipe the screen. You can dampen the cloth with water or an eyeglass cleaner. If the display is very dirty, it can be washed off under a gently running tap.

**WARNING** – Make sure that all ports and doors are fully closed, and that the device is not connected to an external power supply. Do not use chemical or abrasive cleaners.

- **Keep it covered when not in use.** Store the T10x tablet (2024) in a carry case or pouch while you are in transit or not using it.
- **Keep it out of the sun when not in use.** Do not store the T10x tablet (2024) in direct sunlight for a long time unnecessarily. Ultraviolet light and excessive heat from sun-loading heat can damage the display.
- **Use proper touchscreen tools.** Use either fingers or the T10x tablet (2024)'s digital pen, or other devices specifically designed for use with capacitive touchscreens to operate the touchscreen of this device. The use of ballpoint pens, metal tools or other sharp objects to operate the touchscreen may scratch and/or damage the surface of the touchscreen.
- **Avoid drops, tumbles, and abrasives.** The T10x tablet (2024) is designed to resist damage for drops up to 122 cm (4 feet). However, you should protect the display from impact, pressure, and abrasive substances that can scratch it or crack it. The device should not be dropped unnecessarily. Use the screen protectors to keep the touchscreen clean and protected, following the instructions provided on the screen protector packaging.

## Battery care

**Use and storage temperature:** Lithium-ion batteries are sensitive to high temperatures, so keep the device's batteries out of direct sun for long periods, and do not leave batteries in a hot car, especially on a dashboard in full sun or other environments where temperatures can exceed +70 °C (+158 °F). Battery life can be shortened if stored or operated outside of these temperature ranges. Recommended storage temperature is at room temperature (~ +20 °C / +68 °F). When you are using the device or charging the batteries, it is normal for the device and batteries to get warm.

If the interior temperature of the device exceeds normal operating temperatures (for example, in a hot car or in direct sunlight for extended periods of time), you may experience the following as it attempts to regulate its temperature automatically:

- The device stops charging.
- If the device cannot regulate its internal temperature, it may go into a Sleep state until it cools (see [Sleep state, page 23](#)).

Move the device to a cooler location out of direct sunlight and wait a few minutes before trying to use the device again.

**Charging:** Recharge the battery any time; the battery does not need to be empty or low before you recharge it. However, it is best to let the battery run to below 10 percent at least once a month before you recharge it. Charge only at temperatures between 0 °C and +45 °C (+32 °F and +113 °F) for best battery life and performance. Use only the manufacturer designated charging accessories to recharge the batteries.

**Other environmental conditions:** Battery packs are IP65-rated, sealed from water and dust ingress, and are tested for protection from drops when in the tablet from heights up to 1.22m. However to prolong the life of the battery, dry it off with a cloth if it becomes wet, do not intentionally submerge the battery, and take care to avoid unnecessary drops, mechanical shocks, and vibrations.

The T10x tablet (2024) is designed to work in ambient temperatures between -10 °C and +60 °C (+14°F and +140 °F) and to be stored (without the battery) in temperatures between -55 °C and +70 °C (-67 °F and +158 °F). Avoid exposing the device to dramatic changes in temperature or humidity.

# Product specifications

Operating System	Microsoft Windows 11 IoT Enterprise
Processor	Intel 13th Gen Core i7 Processor
Graphics	Intel UHD Graphics
RAM	32 GB
User storage (SSD)	1 TB
Display	10.1" (256 mm) 1000 Nits 1920 x 1200 LCD
Battery & Power	8000 mAh hot-swappable
I/O module connectors	USB-C (Power Input), 3.5mm Audio Jack, USB 3.0 x1
Audio	3.5 mm Headset jack, combined with microphone
Bluetooth	v5.2
Wi-Fi	802.11ax
Camera	Digital Camera 8MP (rear facing)
Sensors	Accelerometer
Environmental	<ul style="list-style-type: none"> <li>• Operating Temperature -10°C to 60°C (14°F to 140°F)</li> <li>• Storage Temperature -55°C to 70°C (-67°F to 158°F)</li> <li>• For battery safety and optimal functionality and performance, the recommended usage temperature range is from -10°C to 45°C (14°F to 113°F)</li> <li>• Humidity 0% – 90% non-condensing</li> <li>• MIL-STD-810H, Method 507.6, Procedure I (Induced. Storage and Transit)</li> <li>• MIL-STD-810H, Method 507.6, Procedure II (Aggravated Cycle)</li> <li>• Water and Dust Proof IP65 (with port access doors closed)</li> <li>• Shock, Drop MIL-STD-810H, Method 516.8, Procedure-I, IV, VI</li> </ul>
Mechanical	<p>Size 7.8 x 11 x 0.76 in (198 x 279 x 19.3 mm) HxWxD</p> <p>Weight 3.1lbs (1.4 kg)</p>



# Introduction

This User Guide describes how to configure and use the Trimble T10x Tablet (2024) powered by the Microsoft® Windows® 11 IoT Enterprise operating system. The information in this guide supplements the information in the Quick Start Guide. Even if you have used other Trimble handheld field computers before, Trimble recommends that you spend some time reading this guide to learn about the special features of the product.

**WARNING** – Before you use this product, make sure that you have read and understood all safety requirements. Failure to follow these safety instructions could result in fire, electric shock, or other injury, or damage to the device and/or other property. For more information refer to [Safety information, page 11](#) of this guide.

- [Registration, page 17](#)
- [In the box, page 17](#)
- [Replacement and spare or optional accessories, page 18](#)
- [Parts of the T10x tablet \(2024\), page 19](#)

## Registration

To receive information regarding updates and new products, contact your local dealer or go to <https://mytrimbleprotected.com/cc/productsRegistration.html>. When you register your device, you can select the newsletter, upgrade, or new product information.

To register your device, you will need the serial number. The serial number is a unique number for your T10x tablet (2024) and is located on a label on the back of the device.

## In the box

A standard pack-out has the following items:

- Trimble T10x tablet (2024) with hot-swappable battery
- AC-DC USB-C power adapter and cord kit
- Digital Pen with tether and battery
- Handstrap
- Screen protector

The T10x tablet (2024) tablet is shipped in “shipping mode”; under the battery there is a pull tab sticker that says Remove. You must remove this tab to take the tablet out of battery shipping mode.

## Replacement and spare or optional accessories

A wide range of replacement and optional accessories are available to purchase for the T10x tablet (2024), including:

Description	Part number
Digital pen (stylus with tether and battery)	124343
Shoulder strap	131932
Single battery charger kit	114113
Spare battery	114111
Spare screen protector	114109
Spare power adapter and cord kit	124732
Spare handstrap	131933

# Parts of the T10x tablet (2024)

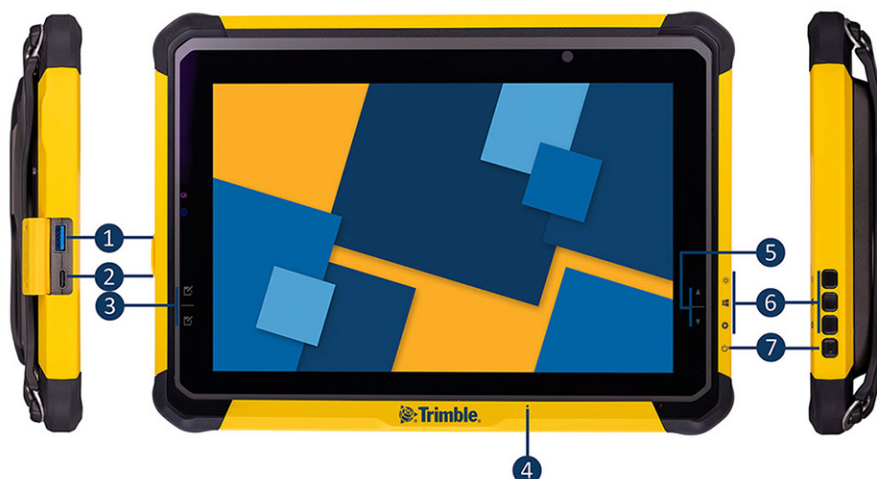

**1** USB-C port (power input)

**2** USB 3.0 (type A) port

**3** Programmable Function keys x 2

**4** Microphone

**5** Brightness Up / Down

**6** Programmable Function keys x 3

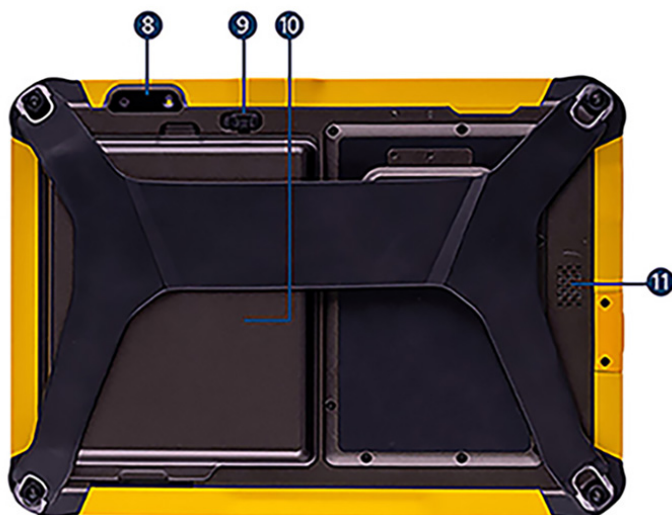

**7** Power button

**8** Camera

**9** Battery Latch. Push the switch up to unlock this latch, then slide the latch left to remove the battery.

**10** Battery

**11** Speaker

# Basic setup and operation

This section tells you how to get started using the T10x tablet (2024) and explains some basic operating system features.

When you start the T10x tablet (2024) for the first time, the Microsoft Windows operating system will take you through some basic set-up steps; follow the instructions on the screen.

For more details on setting up and using the Windows operating system see [Windows help & learning](#) on the Microsoft Windows support website.

- [Charging and power modes, page 20](#)
- [Removing and inserting battery packs, page 24](#)
- [Installing a screen protector, page 24](#)
- [Using the touchscreen, page 25](#)
- [Using the Digital Pen, page 27](#)
- [Using the programmable keys \(Button Manager\), page 28](#)
- [Using the Control Center utility, page 32](#)

## Charging and power modes

**The T10x tablet (2024) tablet is shipped in “shipping mode”; under the battery there is a pull tab sticker that says Remove. You must remove this tab to take the tablet out of battery shipping mode.**

It takes up to 7.5 hours to charge the T10x tablet (2024) battery pack from an empty state. It may take longer if you are using your device for power-intensive activities, for example using GNSS or processing a lot of data while you are charging it.

When the battery pack is charging, the blue-colored Battery LED should blink slowly. If plugging in the AC-DC adapter does not trigger this blinking activity and the LED is solid pink, the battery pack (s) may have been drained substantially. Unplug the AC-DC adapter from the tablet then plug it back in to activate the charging process. You may need to do this a few times. Note if the LED is solid blue, the battery is fully charged.

## Charging the battery

1. Connect the appropriate international plug adapter for your region to the AC adapter.
2. Connect the power cord to the charging port on the device.
3. Plug the power supply into an electrical outlet.

## Checking the battery charge level

You can check the battery level:

- on the Lock screen. When you wake the device, the battery status appears in the lower-right corner of the Lock screen.
- on the Desktop taskbar. The battery status appears on the right side of the taskbar. Tap the battery icon for information about the charging and battery status, including the charge percent remaining.

## LED charging status

A battery LED on the front left of the tablet shows the battery charging status. When connected to mains (AC) power, this shows:

- Solid blue = Battery capacity 100%, battery is not charging.
- Slow flashing blue = Battery capacity <100%, battery is charging.
- Solid pink = Battery capacity is 0%.
- Rapid flashing orange = Battery is in Safety Protection mode.
- Rapid flashing blue = there is no battery in the device.

When not connected to mains power (battery is discharging), it shows:

- Solid blue = Battery capacity is between 100% and 25%.
- Solid orange = Battery capacity is between <25% and 10% .
- Flashing orange = Battery capacity is < 10%.
- Solid pink = Battery capacity is 0%.
- Rapid flashing orange = Battery is in Safety Protection mode.

**NOTE** – If you remove the main battery when the table is running on battery power, the LED will fast-flash orange to warn you that the tablet is running on the internal bridge battery, and you have limited time to replace the main battery. [Insert a charged battery](#) as quickly as possible.

## Using the Power button

To turn on the tablet, push and quickly release the Power button (see [Parts of the T10x tablet \(2024\)](#), page 19).

To put the tablet in Standby mode when it is on, push and quickly release the Power button.

To turn the tablet off for extended storage, power off safely using any software function provided in the operating system that shuts down the device.

To conserve power, use (push and quick release) the Power button to put the tablet in Standby mode while not in use. Pushing briefly on the same button will wake up the system within seconds.

Avoid using the Power button (“hold 4+ seconds” feature) to turn off the tablet; this form of hardware shutdown is intended to be a means of recovery from lockups, and not as normal operation.

## Saving battery power

To save battery power, set the screen to turn off when you haven't used it for a length of time. This state enables the device to resume quickly when you want to start working again.

To further save battery power, set the device to go into Sleep state when you haven't used it for a length of time. Sleep state saves your work and turns off the device. When you start up the device again, you are back where you left off.

To set the screen turn-off time and the Sleep state time, go to **Settings / System / Power & sleep**.

## Wake and unlock



To wake the screen when it has turned off, press any key or swipe the screen.

To wake your device from Sleep state, press any key. After waking your device, to unlock it:

1. Swipe up from the bottom edge of the screen or press a key.
2. At the sign-in screen, enter your password or PIN.

## Restart the device



To restart your device, tap-hold , then tap **Shut down or sign out/ Restart**.

**TIP** – You can also access the **Restart** option from the quick-access Power options above the  icon; tap , then tap the quick-access Power icon, then tap **Restart**.

## Turning off the device

To turn off the device, tap-hold , then tap **Shut down or sign out/ Shut down**.

For information on customizing power management features, see [Power options, page 22](#).

**TIP** – You can also access the **Shut down** option from the quick-access Power options above the  icon; tap , then tap the quick-access Power icon, then tap **Shut down**.

## Power options

The Windows 11 IoT Enterprise operating system comes with pre-defined power options (Balanced, Power Saver, and High Performance). To access Power Options:

1. On the Desktop, tap the **Battery icon** in the **Notifications** bar at the bottom right of the screen, then tap **Battery settings**.
2. Make sure **Power & sleep** is selected in the list on the left, then under **Related settings**, tap **Additional power settings**.



By default, the device is in **Balanced** mode.

You can also set the times for the screen to turn off, and the device to go into Sleep state here.

## Sleep state

If you do not use your device for a number of minutes (as set under **Power & sleep settings** / **Power & sleep**) the screen turns off and the device goes into a power-saving Sleep state. The Sleep state enables your device to resume quickly when you want to start working again.

You can also manually place the device into Sleep state; tap-hold , then tap **Shut down or sign out/ Sleep**.

**TIP** – You can also access the **Sleep** option from the quick-access Power options above the  icon; tap , then tap the quick-access Power icon, then tap **Sleep**.

To wake the device from Sleep state, press the Power button. After waking your device, to unlock it:

1. Swipe up from the bottom edge of the screen.
2. At the sign-in screen, tap **Sign in** and if required enter your password or PIN.

**NOTE** – Sleep state is different from the screen 'turning off' to save power, from which you can 'wake' the screen by tapping / swiping it.

## Making your battery last longer

Following are some practical suggestions that you can do to maximize the operating time of the battery:

- Enable Power Management, and choose a power plan that saves power. A power plan is a collection of hardware and system settings that control how the device manages power.
- Decrease the display brightness to the lowest comfortable level .
- Shorten the length of time before the operating system turns off the display.
- If you use a USB flash drive, unplug it when you are not using it. Many USB devices use power just by being connected.
- Turn off the wireless radios when you are not using them. See [Using wireless networks, page 41](#).
- Turn off the device when you are not using it. See [Turning off the device, page 22](#).

For more information on making your battery charge last longer, refer to the Microsoft Windows support site on [support.microsoft.com](https://support.microsoft.com).

## Removing and inserting battery packs

The battery pack in the T10x tablet (2024) can be charged inside the device, or using the Battery charger accessory (Trimble T10x Battery Charger Kit / single battery P/N 114113).

The battery pack in the T10x tablet (2024) is also hot swappable; you can remove the battery pack while the T10x tablet (2024) is still running, and replace it with a freshly charged battery pack without shutting down or needing to restart the device.

1. Slide the latch to the unlocked position
2. Lift the battery pack from the battery compartment.



3. Insert a charged battery pack into the battery cavity—insert the bottom of the battery first to allow the battery tongues to seat correctly.
4. Slide the battery latch to the locked position.



If you require additional battery packs, contact your local Trimble Authorized Reseller.

## Installing a screen protector

The T10x tablet (2024) is fitted with a chemically strengthened glass touchscreen, which is highly resistant to abrasion and impact damage. However to ensure maximum protection, it is recommended that you use a Trimble-approved toughened glass T10x tablet (2024) screen protector.

To install a screen protector:

1. Place the device on a clean, flat surface. Make sure your hands are clean.
2. Clean the touchscreen with a damp cloth, alcohol wipe or similar.
3. Polish and dry the screen with a lint-free cleaning cloth.
4. Remove the protective film from the screen protector that is labeled **Back**. This part will be in contact with the tablet screen. Do not touch the “Back” section after removing the film.
5. Align the screen protector with the glass portion of the display. Use the edge of the display as a guide. The screen protector should line up evenly with the edges of the screen.
6. Carefully lay the screen protector down on the screen. If you make a mistake and the glass looks off-center, you can gently lift the screen protector up and realign it. Then, once the



protector is on the screen, give it a soft press in the center and allow the adhesive surface to grip to the screen naturally.

- If there are any bubbles remaining, use the cloth provided to gently smooth them toward the edges of the screen protector.





For more information on where to purchase the correct screen protector for your device, contact your local Trimble dealer.





## Using the touchscreen

The T10x tablet (2024) can be easily operated with the touchscreen (using your fingers or the Digital Pen), a mouse, and the keypad. You can easily switch between any of these input methods.

### Main touchscreen input gestures and functions supported on the T10x tablet (2024)

The table below describes the main touchscreen input gestures and functions supported on this device.

Tap	Tap once on something.	Opens/executes the action of what you tap on. To enter text, tap where you want to type; the onscreen keypad displays.
	Press-hold your finger or the Digital Pen down for a few seconds.	Shows a menu with options related to what you're doing (like right-clicking with a mouse). On the pop-up menu that appears, tap the action you want to perform.
	Double-tap	Double-tap on something.
	Double-tap on something.	Tap quickly twice on a webpage, map, or other screen to zoom. Double-tapping after pinching to zoom in some apps, such as Browser, reflows a column of text to fit the width of the screen.
Slide / swipe	Slide / swipe your finger or the Digital Pen across the screen.	Scrolls through what's on the screen. Quickly move your finger across the surface of the screen, without pausing when you first touch it, to scroll a page or a list up or down. Scrolls vertically or horizontally.
		

<p>Drag</p> 	<p>Drag your finger or the Digital Pen across the screen.</p>	<p>Hold your finger or the Digital Pen on an item for a moment and then, without lifting your finger/the Digital Pen, move across the screen until you reach the target position.</p> <ul style="list-style-type: none"> <li>• Drag in a list to select multiple items.</li> <li>• Drag items on the screen to reposition them.</li> </ul>
<p>Pinch / stretch</p> 	<p>Pinch your thumb and forefinger together or move them apart.</p>	<p>Zooms in or out of a website, map, or picture.</p>
<p>Rotate</p> 	<p>Put two or more fingers on an item and then turn your hand.</p>	<p>Rotate the screen left or right in apps that support it, such as Maps.</p>
<p>Swipe from edge</p> 	<p>Swipe in from an edge of the screen.</p>	<ul style="list-style-type: none"> <li>• Left edge swipe. Displays the Task View, the universal task-switching interface. See <a href="#">Using Task View and virtual desktops, page 38</a></li> <li>• Right edge swipe. Displays the Action Center. See <a href="#">Using the Action Center, page 37</a>.</li> <li>• Top edge swipe. Displays the Notification bar.</li> <li>• Bottom edge swipe. Displays the taskbar when the currently-running app is displayed full screen.</li> </ul>

## Using the onscreen keypad

You can type on the device using the touchscreen keypad.

To access the onscreen keypad, tap in a text field. To hide the keypad, tap X in the top right corner of the keypad.

**NOTE** – You can also use an external keyboard with the tablet.

## Using Trimble software that provides a keypad

The T10x tablet (2024) operating system provides an on-screen (touch) keypad. If you use Trimble software that also provides an on-screen keypad, when you run the software on the T10x tablet (2024), you may have two keypads appearing whenever you are in a text field in the software. To prevent this, configure the keypad settings correctly in the Windows operating system and in the software.

To use the operating system keypad:

1. Configure the Trimble software to use the operating system's keypad. Refer to the user documentation for the software for full details; typically, in the **Keyboard** list, select **Operating system**.
2. From the Windows desktop, swipe in from the right to access the **Action Center**. Ensure **Tablet mode** is **On**.

To use the Trimble software keypad (preferred option when using, for example, Trimble Access software):

1. From the Windows desktop, swipe in from the right to access the **Action Center**. Ensure **Tablet mode** is **Off**.
2. Go to **Windows Settings**, tap **Devices / Typing** and turn off the **Show the touch keypad when not in tablet mode and there's no keyboard attached** setting.
3. Configure the Trimble software to use the software's keypad. Refer to the user documentation for the software for full details.

## Using a USB or Bluetooth mouse and keyboard

You can attach a physical keyboard, mouse and other peripherals to your device via USB or Bluetooth wireless technology. For more information see [Using accessories and connecting to other devices, page 43](#).

## Using the Digital Pen

Take notes, draw, navigate, and mark up documents directly on the screen using the Digital Pen. The Digital Pen is an active pen based on capacitive-coupled sensing technology for use on capacitive touch screens.

The Digital Pen requires a AAAA battery.

The Digital Pen is designed to work with the tablet automatically; no Bluetooth or Wi-Fi connection is required. The Pen works once it is close to the touchscreen.

**NOTE** – When using the Digital Pen, the screen will not respond to finger touch.

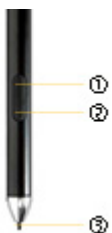

- 1 Pen Button:** For quick access to the right-click menu, press and hold the button, touch the screen with the Pen tip and release the button to bring up the right-click menu.
- 2 Eraser Button:** Works as an eraser to delete markings made with the Digital Pen on the screen.
- 3 Pen Tip:** Pressure-sensitive tip allows natural handwriting and drawing. Combined with apps that support pen pressure, the Digital Pen works like a real pen.

## Replacing the battery

**TIP** – If the Pen is no longer responsive across the touchscreen, the battery may be depleted and may need replacing.

1. Unscrew the top cap of the Digital Pen.
2. Remove the battery, and then replace with a new AAAA battery. Replace the top cap.

## Turning the Digital Pen on / off

Click the Pen Button (1) to turn the Digital Pen on.

When the Pen has been idle for two minutes, it automatically turns off.

## Using the Pen Clip to tether the Digital Pen

Attach the Pen Clip to the rubber handstrap on the back of the tablet.

Push and insert the Digital Pen into the Pen Clip from the left or right side. Or, directly press the Digital Pen into the Pen Clip from the top.

**CAUTION** – Do not place the Digital Pen with the buttons facing inside the Pen Clip, as this might damage the buttons.

## Caring for the Digital Pen

**CAUTION** – Read the instructions carefully. Failure to follow the instructions could result in damage to the Digital Pen and voiding its warranty.

- Use the Digital Pen only in accordance with the operation guide.
- Do not attempt to open or disassemble the Digital Pen (except to change the battery) as this will void the warranty.
- Do not expose the Digital Pen to extreme temperatures or direct sunlight.
- If there is any damage or broken parts, do not use the Digital Pen. Contact your reseller or service provider.
- Clean with a dry cloth. Do not use water, soap, detergent, or other chemicals.
- Operating temperature: 0 °C to +50 °C (+32 °F to +122 °F)
- Storage temperature: -30 °C to 70 °C (-22 °F to +158 °F)

## Using the programmable keys (Button Manager)

Use the Button Manager to manage the physical buttons on T10x tablet to quickly access certain functions such as the on-screen keyboard, Windows key trigger, adjust the system volume or screen brightness, and launch user-defined applications. Predefined buttons are set up for most common uses.

# Accessing the Button Manager from Windows Desktop

To launch the Button Manager application from the Windows System Tray, tap .

The interface has three main parts:



- **Button icons:** these are located close to physical buttons on the tablet. The icons show the function currently assigned to the button.
- **Button functions:** lists all available functions that can be assigned to the buttons on the T10x tablet (2024).

**NOTE** – The functions available will depend on the tablet model. Some functions displayed may not be available.

- **Button modes:** The button assignment for Windows logon page and normal desktop page is different. Not all functions are available for Windows logon mode. If the system has more physical buttons, you can assign one button as an **Fn** button, so that when pressed in combination with another button it has another set of functions.

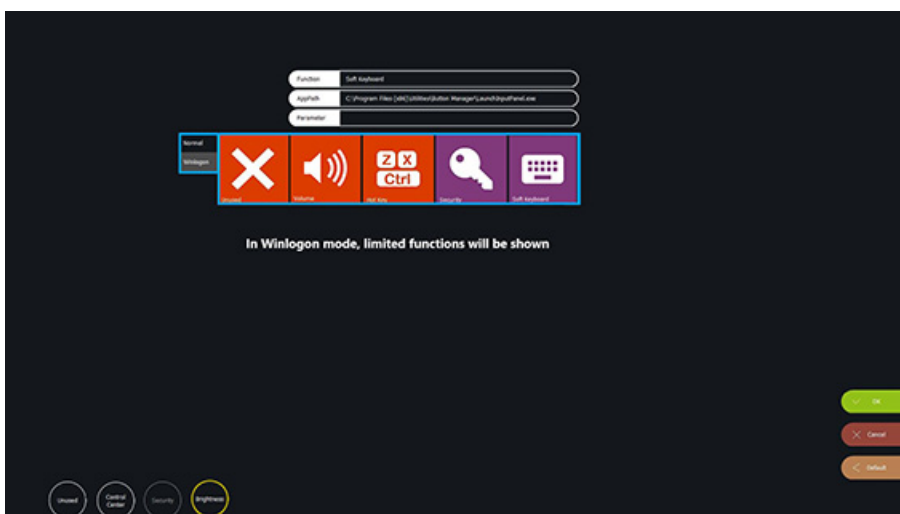

## Assigning a function to a button





Buttons are predefined for most common uses. To view / change the function assigned to a button:

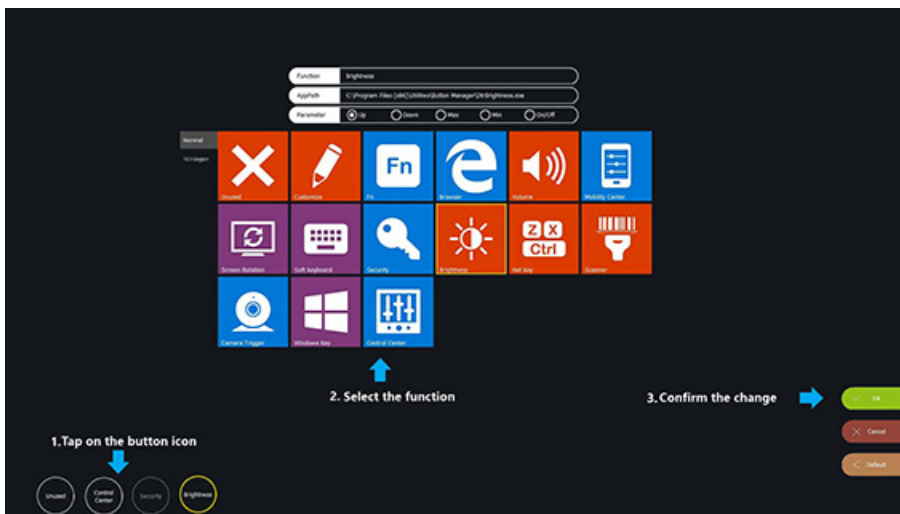











1. Tap the button icon you want to work on. The function currently assigned to the button is highlighted in the button function area.
2. In the button function area, tap the icon (function) that you want to assign to the button.
3. If the selected function has a second-level parameter, you will be prompted to input your options. For example; Brightness has the options of Up, Down, Max, Min, On/Off.
4. Tap **Ok** to confirm your selection. The function you selected is now assigned to the button.

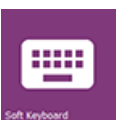

You can continue to configure the rest of the buttons as needed.

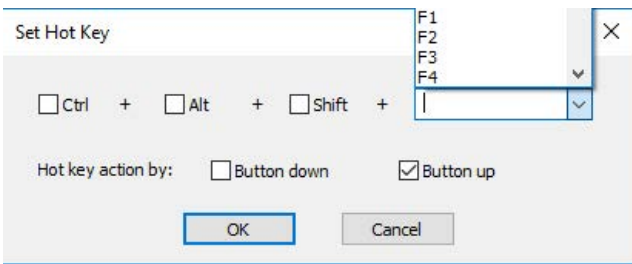

By default, all functions are configured for **Normal** desktop mode. If you want to assign a button to function under **Winlogon** mode, you must switch the mode to **Winlogon**, then follow the steps above to assign a function to a button.

Button	Description
	No function is assigned to the button. Use this to remove a function assigned to a button.
	Use this to launch an application within a specified parameter. It has a second option to input necessary application path and parameter. 
	Use this to define a button as the Fn button. It must be combined with other buttons to function. It is recommended that you do not use this option unless you need more button functions than there are physical buttons on the device.

Button	Description
	Use to launch Microsoft Edge.
	Use to adjust system sound volume, and second option to choose volume Up, Down, or Mute. 
	Use to launch <a href="#">Windows Mobility Center</a> .
	Use to trigger screen rotation, and second option to choose rotation degree of 90, 180, or 270 degrees. 
	Use to launch the onscreen keyboard.
	Use to change brightness settings. A second option allows you to choose brightness Up, Down, Maximum, Minimum, and screen On/Off. 
	Use to set a Hot Key. A second option allows you to choose Ctrl, Alt, Shift, and the key. 
	Use to launch the Camera app. Note this only works with the default (DTMSCAP) Camera app.

Button	Description
	Use to trigger the system Security key (Ctrl-Alt-Del combination).
	Use to trigger the Windows Start key.
	Use to launch the <a href="#">Control Center utility</a> .

## Using the Control Center utility

The Control Center is the central portal to access major system modules and settings. Authorized users can enable/disable radios (Wi-Fi, Bluetooth) and/or optional modules. All users can change the settings for all modules to adjust the LCD brightness, screen orientation, and touch modes based on where and how the tablet is being used so it benefits end-users the most.

## Accessing the Control Center from the Windows Desktop

From the Windows System Tray, tap  to launch the Control Center application.

When the application is launched, the Control Center runs under Normal User Mode. In this mode, you cannot turn on/off the modules, like Wireless, Bluetooth, and Cameras. You will see the module and settings icons below.

**NOTE** – The module icon(s) are displayed only when there is/are related module(s) installed on your tablet and laptop.



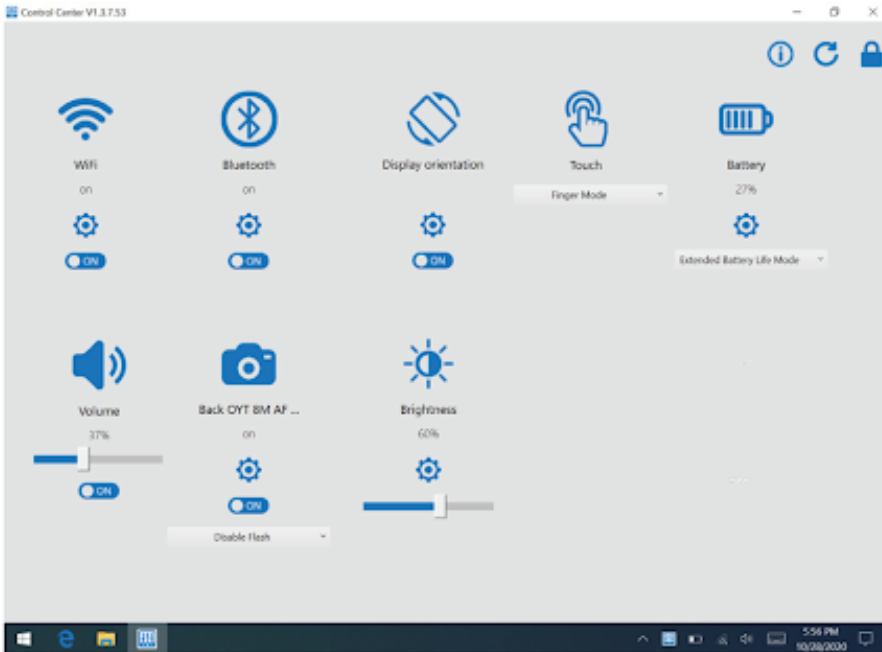

To access Authorized User Mode, click the lock icon on the top right corner of the application window. A dialog opens prompting the authorized user to enter the password. The default password is P@ssw0rd.

After setting up, the authorized user can tap  to exit Authorized User Mode.

The Control Center automatically refreshes the module status. To manually refresh the module status, tap .

To change the authorized user password, tap . In the dialog that opens, enter the current password, then the new password. Tap **OK** to save the settings.

## Module function settings

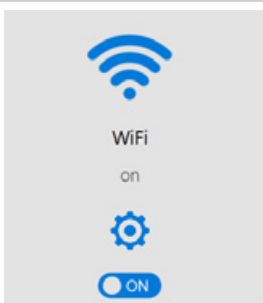

Tap the **On/Off** button to enable or disable the WLAN connection.\*

Tap  to enter the Microsoft Windows Settings for the advanced adjustment.

\*Can be set up only under the Authorized User Mode.

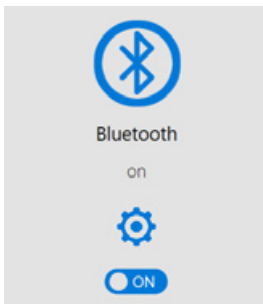

Tap the **On/Off** button to enable or disable the Bluetooth connection.\*

Tap  to enter the Microsoft Windows Settings for the advanced adjustment.

\*Can be set up only under the Authorized User Mode.

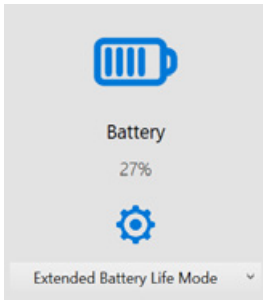

The drop-down menu allows you to quickly switch the power modes of the tablet. Select **Max Battery Performance Mode** to enable the system performance, and to save the system power, select **Extended Battery Life Mode**.

**Max Performance Mode:** to charge the battery pack(s) to full design capacity.

**Extended Battery Life Mode:** to charge the battery pack(s) to 80% design capacity to extend the lifespan.

**NOTE** – By default, the setting is **Extended Battery Life Mode**.

Tap  to enter the Microsoft Windows Settings for the advanced adjustment.

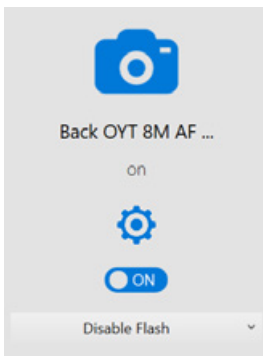

Tap the **On/Off** button to enable or disable the Back Camera module.\*

The drop-down menu allows you to enable and disable the LED flash light.

Tap  to enter the Microsoft Windows Settings for the advanced adjustment.

The LED flash lights are for certain models, and the drop down menu is only available when there are LED flash lights installed.

\*Can be set up only under the Authorized User Mode.

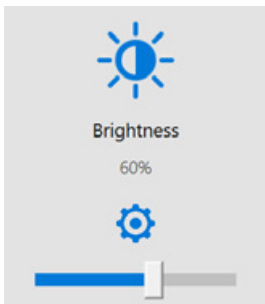

Slide the bar to adjust the screen brightness, supports 0% to 100%.

Tap  to enter Dimmer Control.

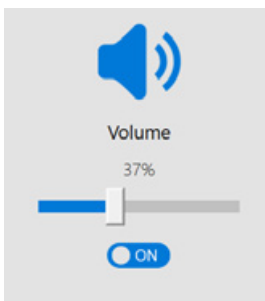
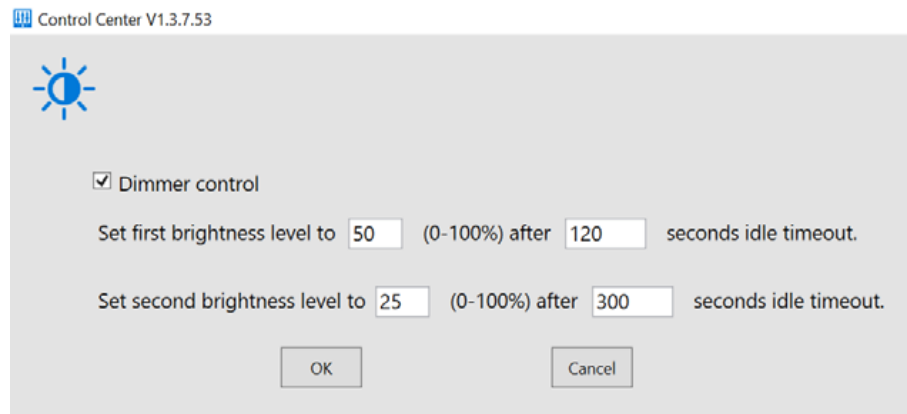

Tap the **On/Off** button to turn the speaker on or off.

Slide the bar to adjust the volume, supports 0% to 100%.

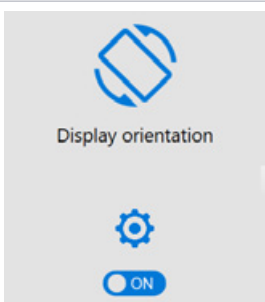

Tap the **On/Off** button to lock or release the screen rotating.

Tap  to enter the Microsoft Windows Settings for the advanced adjustment.

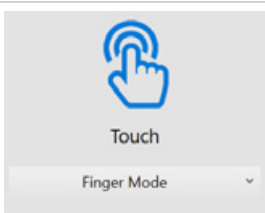

The drop-down menu allows you to quickly select the screen sensitivity. It supports Finger Mode, Glove Mode, and Water Mode.

**NOTE** – Water Mode supports workable capacitive touch while there is water on the screen.



# Using the Windows operating system

This section introduces some basic information on using the Windows 11 IoT Enterprise operating system on the T10x tablet (2024). For comprehensive information, go to <http://windows.microsoft.com>.

- [Using accounts, page 36](#)
- [Using the Start menu, page 37](#)
- [Using the Action Center, page 37](#)
- [Using the Windows Mobility Center, page 37](#)
- [Using Task View and virtual desktops, page 38](#)
- [Settings, page 38](#)

## Using accounts

When you set up the T10x tablet (2024), an account is set up for you. You can create additional accounts later for each user of the device, so that each person using the device can have their own settings.

To set up additional accounts and to change account settings, tap , then tap the quick-access Accounts icon . Or, go to  / **Settings** / **Accounts**.

## Sign in

1. Press the Power button to turn on or wake the T10x tablet (2024).
2. Swipe up on the screen.
3. If there are multiple accounts set up on the device, select your account from the list. Tap **Sign in** and enter your password (if one has been set).

## Sign out

Tap-hold , and tap **Shutdown or sign out**, then tap **Sign out**.

## Using the Start menu

Tap  open the **Start** menu.

At the lower left of the **Start** menu, you'll find quick links to **Account** settings, all other **Settings**, and **Power** (shut down, sleep, and restart).

The apps you've used most often appear at the top of the **Start** menu.

Tiles on **Start** act as quick links to apps. You can rearrange, resize, add, and remove tiles whenever you want. To add an app tile, tap-hold it in the **Start** menu and drag-drop it to the **Tiles** area. For more information, see [Organize your apps](http://windows.microsoft.com) on <http://windows.microsoft.com>.

## Using the Action Center

Swipe in from the right edge of the screen or tap **Action Center**  on the taskbar to open the Action Center. Examples of what you can use the Action Center for include:

- viewing notifications
- adjusting common settings like Wi-Fi connections or screen brightness
- creating a wireless connection to other devices

For more info, see [Find your notifications](http://windows.microsoft.com) on <http://windows.microsoft.com>.

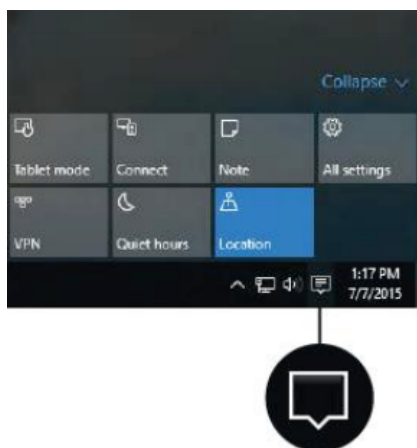

## Using the Windows Mobility Center

Tap-hold , and tap **Mobility Center**. Use the Mobility Center to, for example:

- view device information
- adjust common settings such as screen brightness, screen rotation, and volume

- manage Wi-Fi and Bluetooth connections

## Using Task View and virtual desktops

Task View allows you to quickly hide all windows and show the desktop, find an open window, and manage windows across multiple "virtual desktops".

Swipe in from the left edge of the screen or tap **Task View** on the taskbar to display all open windows, access any virtual desktops you have set so you can switch between them, and add more virtual desktops if you need to.



## Settings

Tap  / **Settings** for access to all your settings.

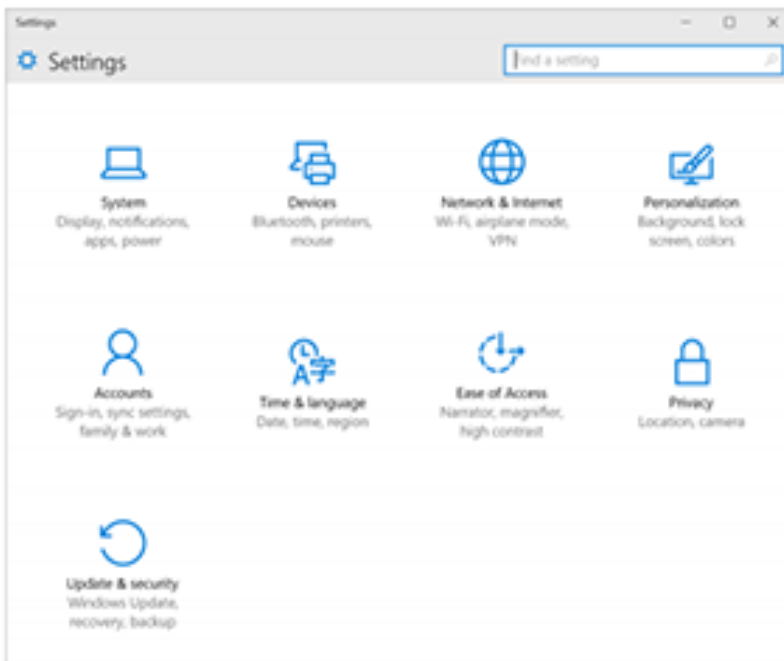



## Display settings: adjusting the backlight

The T10x tablet (2024) is equipped with a high brightness outdoor readable display. You can easily increase the brightness of the display to increase the readability of the device in bright sunlight conditions, or turn down the brightness to help conserve battery power when working indoors or in dull conditions. You can also have the device automatically adjust the backlight power depending on the ambient light conditions.

To quickly adjust the display brightness setting, use the screen arrow keys on the right hand side of the screen to adjust the brightness up or down in 10% increments.

Alternatively:



1. Swipe in from the right edge of the screen or tap **Action center**  on the taskbar to open the Action center, then expand the quick-access icons if they are collapsed.
2. Tap the brightness icon  to adjust the display brightness setting. The backlight cycles between 0%, 25%, 50%, 75%, and 100% power. Tap until you reach the backlight level that best suits your conditions.

You can also manually adjust the backlight setting from the **Display** dialog:

1. Tap  / **Settings** / **System** / **Display**.
2. Use the brightness level slider to fine tune the display brightness level.

## Display settings: rotation lock

The T10x tablet (2024) is equipped with orientation sensors that can detect if your device is in portrait or landscape orientation. The operating system can automatically adjust the display to match your device orientation, or you can lock the orientation.

To adjust the automatic display orientation feature, swipe in from the right edge of the screen or tap **Action center**  on the taskbar to open the Action center, then select rotation lock  to turn rotation lock on or off.



# Using wireless networks

The T10x tablet (2024) supports wireless connectivity, allowing you to connect to wireless networks using the built-in Wi-Fi radio (also sometimes called Wireless LAN, WLAN, or 802.11).

- [Airplane mode, page 41](#)
- [Working with Wi-Fi networks, page 41](#)

## Airplane mode

If you are traveling on an airplane, or don't need to use wireless functions on the T10x tablet (2024) for a while, use Airplane mode to turn on or off all wireless radios with transmitting features built into the T10x tablet (2024), including Bluetooth, Wi-Fi, as well as any wireless radios connected to the T10x tablet (2024).

**TIP** – You can also turn on Airplane mode from the operating system; tap the Wireless network icon  in the bottom-right corner of the screen, then tap **Airplane mode**.

## Working with Wi-Fi networks

Using Wi-Fi you can connect to a wireless network and browse the internet, download apps, send email messages, access online services, or access other computers and devices on your network.

Before you can send and receive data over Wi-Fi, you need to turn on Wi-Fi on the T10x tablet (2024) and connect to a wireless network.

## Connecting to Wi-Fi

1. Tap the Wireless network icon  in the bottom-right corner of the screen. If it isn't showing, swipe in from the right side of the screen to open the Action Center, then tap **Network**.  
A list of available wireless networks appears.
2. Select the Wi-Fi network you want to connect to.
3. Tap **Connect**. If prompted, enter your network security key (network password), and tap **Next**.

4. If prompted, choose whether you want to share with other computers and devices on the network. Select **No** if you are connecting to a network in a public place like a café.

You can check your connection by opening the browser and connecting to the internet; tap , and select Microsoft Edge. Some wireless networks may require you to enter a password in a browser window.

## Disconnecting from a Wi-Fi network

1. Tap the Wireless network icon  in the bottom-right corner of the screen.
2. Select the network that has a **Connected** status.
3. Tap **Disconnect**.

## Forgetting a Wi-Fi network

If you do not want your device to automatically connect to a saved Wi-Fi network, you can forget that network.

To forget a wireless network so it no longer appears in your list of networks:

1. Tap  / **Settings**.
2. Select **Network and Internet / Wi-Fi / Manage known networks**.
3. In the list of networks that appears, tap the network you want to remove, and tap **Forget**.

# Using accessories and connecting to other devices

You can connect monitors, accessories, and other devices directly to your T10x tablet (2024) using USB or Bluetooth.

- [Connecting to USB accessories, page 43](#)
- [Connecting to Bluetooth accessories, page 43](#)

## Connecting to USB accessories

The T10x tablet (2024) has a USB port for connecting USB devices, such as a flash drive, scanner, or printer. The T10x tablet (2024) has built-in support for mass storage devices and human interface devices.

Other types of USB devices may require drivers.

To connect a USB device, flip open the port cover on the left side of the T10x tablet (2024) and plug the device cable into the USB port.

## Connecting to Bluetooth accessories

The T10x tablet (2024) has embedded Bluetooth wireless technology—a short-range wireless communication technology that allows wireless data transfer and communication between devices over a distance of up to 10 meters (30 feet).

Use the Windows System Tray, Windows Mobility Center, or Action Center to configure Bluetooth wireless connections. Follow the instructions and options in the Bluetooth application.

**TIP** – To save battery, turn off Bluetooth when you are not using it. Bluetooth is off when the device is in [Airplane mode](#).

Before you can transfer data or communicate between your T10x tablet (2024) and another Bluetooth enabled device, you must pair the T10x tablet (2024) and the device.

To pair and connect a Bluetooth device with the T10x tablet (2024) :

1. Turn on the Bluetooth device and make it discoverable. To learn how to do this, check the documentation for the Bluetooth device or go to the manufacturer's website.
2. Tap  / **Settings** / **Devices** / **Bluetooth**.
3. Make sure the slider is set to On. The T10x tablet (2024) searches for Bluetooth devices.
4. In the list of Bluetooth devices, tap the device you want to pair with the T10x tablet (2024) .
5. Follow the on-screen instructions to finish pairing the devices.
6. If the other device requires a passcode (sometimes called a pairing code), you'll be prompted for it. If you don't know the passcode, check the information that came with the device or the manufacturer's website.

# Using the camera

The T10x tablet (2024) is fitted with an 8 MP rear-facing camera.

- [Taking photos and videos, page 45](#)
- [Changing camera settings, page 45](#)
- [Enable the Camera app to access your location to geo-tag photos, page 46](#)
- [Viewing photos and videos, page 46](#)

## Taking photos and videos

By default, the built-in Camera app is ready to take photos, but you can switch easily between photo and video mode.

Before you use the camera, make sure you have removed the protective film on the camera and flash window.

To take a photo or record a video:

1. Tap  / **Camera**.
2. Tap the on-screen **Camera** button to take a picture, or tap the **Video** icon to switch modes, then tap the icon again to record a video.

Your latest photo or video shows as a thumbnail in the lower right corner of the window. You can tap this to access the Pictures library. See [Viewing photos and videos, page 46](#) for more information.

## Changing camera settings

Tap  / **Camera** to launch the Camera.

To change settings, do any of the following as required:



- To manually set the brightness or exposure (Exposure compensation), tap the small arrow (left center of the window, near the **Watch** icon), then tap the +/- icon. A manual slider appears on

the right side of the window, around the Camera button. Move the slider upwards to brighten your photos and videos, or move it downwards to darken them.

- To set the focus to automatic (default) or manual, tap the icon labeled **Auto** (left center of the window near the **Watch** icon). A manual slider appears to adjust focus; move the slider upwards or downwards to set the focus as required.
- To set a time delay, tap the **Watch** icon (left center of the window). The timer enables you take pictures with a delay of 2, 5, or 10 seconds. To select the required delay, tap the **Watch** icon until the number of seconds' delay that you want displays (shown as a small number near the **Watch** icon). When a time delay is set, each time you take a picture, the Camera app displays a timer in the middle of the window that indicates when the photo is captured.
- Tap  in the top right corner of the window to access more settings, such as:
  - what happens when you press and hold the camera button.
  - the photo aspect ratio.
  - the framing grid.
  - video recording settings, like frames per second or flicker reduction.
  - where photos and videos are saved. By default, your photos and videos are saved to **Pictures / Camera Roll**.
  - location info. See [Enable the Camera app to access your location to geo-tag photos, page 46](#) for more information.

To hide the camera settings, tap anywhere in the window away from the **Settings** panel.

## Enable the Camera app to access your location to geo-tag photos

1. Tap  / **Camera** to launch the Camera app.
2. Tap  in the top left corner of the screen.
3. Under **Related settings**, tap **Choose whether camera can use location info**.
4. Tap **Yes** to confirm you want to switch apps.
5. In the **Settings** screen, make sure **Location** is selected in the list on the left.
6. Under **Location**, if the device shows Location for this device is off, tap **Change**, and tap the **Location for this device** switch to turn it **On**.
7. Scroll down to **Choose apps that can use your precise location**, and tap the **Camera** switch to turn it **On**.
8. Close the **Settings** app to return to the **Camera** app.

## Viewing photos and videos

By default, your photos and videos are saved to the **Camera roll** on the T10x tablet (2024).

There are several ways to look through and work with your photos and videos:

- In the **Camera app**, tap the thumbnail of the last photo or video you captured; this thumbnail appears in the bottom right corner of the window. The photo / video opens in a new window. Use the arrows to scroll through the collection.  
From within this window, you can also quickly go to your **Pictures** library—tap **View All photos** in the top left corner of the window.
- Open **File Explorer**, and go to your **Pictures** library and open the **Camera roll** or the folder you have saved photos / videos in.
- Use the **OneDrive** app.

# Using the pre-installed apps

The T10x tablet (2024) comes with a range of useful pre-installed software.

- [Bundled Microsoft apps](#)
- [Getting more apps](#)

## Bundled Microsoft apps

Here are some of the useful productivity applications that come bundled with your T10x tablet (2024) powered by the Windows operating system.

- **OneNote.** Use the OneNote app on your device to take notes and store them in the cloud. For more information, see [www.onenote.com](http://www.onenote.com).
- **Mail.** Mail automatically organizes your inbox. You can add multiple accounts and access them through this single point.
- **Calendar.** Use Calendar to manage your schedule.
- **People.** The People app brings all your contacts together in a single space. See each contact's email address, phone number, website, and other information at a glance.
- **Microsoft Edge.** Microsoft Edge gives you fast and fluid access to the internet. Open pages in Reading View, save them to your reading list, or take notes right on the page using inking. See *Get to know Microsoft Edge* on [windows.com](http://windows.com) for details.
- **Camera.** The Camera app lets you take regular photos, photo bursts, or video. See [Using the camera, page 45](#) for more information.
- **Weather.** The Weather app offers hourly, daily, and 10-day forecasts as well as historical information and annual weather trends.

## Getting more apps

You can install more apps and programs from the Windows Store, websites, or a CD or DVD. To learn more go to <https://support.microsoft.com>.

To find applications for the T10x tablet (2024), go to Microsoft Store on [www.microsoftstore.com](http://www.microsoftstore.com).



# Troubleshooting

This section contains answers to some common troubleshooting questions. If you encounter problems when using the T10x tablet (2024), try the following troubleshooting tips to detect and solve the problem. If problems persist, contact your local distributor for support.

- [Performance issues, page 49](#)
- [Wireless connectivity issues, page 50](#)
- [Power and battery issues, page 51](#)
- [Restarting or resetting the operating system, page 52](#)
- [Operating system and software updates, page 53](#)
- [Repairing your device, page 54](#)

## Further assistance and support with the Windows 11 IoT Enterprise operating system

### Performance issues

#### Device is running slowly

- Operating system updates may be installing.

The Windows operating system may have automatically downloaded software or operating system updates, and is installing these in the background. While these updates are being installed, system performance may be reduced, or wireless connectivity speed may appear to be slower than normal.

- You may have too many background applications running.

Some programs start automatically and run in the background. You can disable these programs at startup to improve Windows startup time and overall system performance.

- You may have malware or a virus.

A virus or other malicious software could cause your device to run slowly. Check whether your device has a virus by using Windows Defender, which is included with Windows, or refer to the documentation for your third-party antivirus software.

- Check your wireless network speed.

If the apps you are using are connecting to the internet, a poor network connection may be causing them to run slowly. For detailed information on checking your network, see [Wi-Fi speed is slow, page 50](#).

- Check for low disk space.

You may be able to improve performance if you free up some disk space on your device. Disk Cleanup can delete temporary and system files, empty the Recycle bin, and remove apps and data that you no longer need.

- Your device may have overheated.

If you are using your device in a hot environment and/or are using a processor or memory-intensive, your device may have become too hot. Move your device to a cooler spot, wait five minutes, and see if it runs faster.

## Wireless connectivity issues

### Wi-Fi speed is slow

- Your network is running slow for all devices.

You should first check to see whether your network is slow on another device. Can you connect to your wireless network and browse the web at normal speeds from another device? Try running a Network Speed Test to ensure your internet connection is functioning normally.

- Your Wi-Fi signal is weak.

Look at the Wireless network icon in the taskbar.

This icon shows your current signal strength. If the icon is partially dimmed, move your device closer to your wireless router to see if the signal improves. If your router is broadcasting on both a 2.4 GHz and 5 GHz frequency, try connecting to a different frequency. In general, a network operating on the 5 GHz frequency will be faster and less susceptible to interference, but will have a shorter range than a 2.4 GHz network.

### Wi-Fi is not connected

- There is no Wi-Fi connectivity.

Make sure that the tablet is not in Airplane mode; Airplane mode must be OFF in the operating system. See [Airplane mode, page 41](#).

# Power and battery issues

## Battery will not charge

- The battery is overheated, or too cold.

The battery will charge between 0 °C and +45 °C (+32 °F and +113 °F). If you have been using or storing the battery and/or device in a particularly hot or cold environment, the battery may be outside the safe charging temperature range. Sensors in the battery will prevent the battery from charging until its temperature returns to a normal level.

- The battery is not installed correctly.

If the battery is not installed correctly in the device or the battery charger, it may not have a proper connection and will not charge.

- The battery terminals are dirty or corroded.

If the terminals of the battery are dirty or corroded, it may not have a proper connection and will not charge.

## Device will not start up

- The battery pack does not have enough charge to power the device.
- The battery is not correctly installed.

The device may not be receiving power from the battery if it is not installed properly. Remove the battery, then replace it, pressing down on both corners until it clicks into place. See [Removing and inserting battery packs, page 24](#).

## Device suddenly turns off during use

- Make sure you are not accidentally pressing the Power button.

The Power button is located on the lower front left of the device. Make sure that while gripping the device that you are not accidentally pressing the Power button and suspending the unit.

- The device may have run out of power and gone into critical suspend mode.

If your battery charge level gets too low, the device will automatically go into a hibernate mode to prevent loss of data. If the battery charge is too low, connect the device to external power.

If you regularly run out of battery power while in the field, consider carrying a spare battery with you. The device supports hot-swapping of the battery, which means that the device will keep running for up to two minutes while you remove the battery pack and replace it with another.

## Device shuts down when hot-swapping the battery

- Hot-swap battery is not sufficiently charged.

The hot-swap back-up battery allows you to change the main device battery pack for a charged one without shutting the device down. To function correctly, the hot-swap battery must have at least 90 minutes of charging time before it can work properly. If you attempt multiple hot-swaps

without allowing the back-up battery to recharge, your device may shut down when the battery pack is removed

## Restarting or resetting the operating system

If your device becomes unresponsive, and the troubleshooting guide does not resolve the problem, you need to restart or reset your device.

For detailed instructions on the recovery options in Windows 11, refer to the Microsoft support pages on Windows 11 recovery options at [www.support.microsoft.com](http://www.support.microsoft.com).

### Restarting your (unresponsive) device

If your device is no longer responding to touchscreen or keypad input, you may need to force it to restart by removing power from the system.

**CAUTION** – Restarting the system by holding down the Power key removes power to the CPU. Any unsaved files and settings will be lost.

To force your device to restart:

1. Press and hold the Power key until the device shuts down (~15 seconds).
2. Restart your device by pressing the Power key.

### Resetting your device

If restarting your device does not resolve the issue that you are seeing, resetting it might help. Resetting lets you choose to keep your files or remove them, and then reinstalls the operating system.

To reset your device:

1. Tap  / **Settings** / **Update & security** / **Recovery**.
2. Select **Get started** then follow the onscreen instructions to reset your device.
3. At the reset menu, select one of the following:
  - **Keep my files.**
    - Reinstalls the Windows operating system and keeps your personal files.
    - Removes apps and drivers you installed.
    - Removes changes you made to settings.
    - Removes any apps your dealer or distributor installed.
  - **Remove everything.**
    - Reinstalls the Windows operating system and removes all your personal files.
    - Removes apps and drivers you installed.
    - Removes changes you made to settings.

- If you're planning to donate, recycle, or sell your device, use this option and choose to fully clean the drive. This might take an hour or two, but it makes it harder for other people to recover files you have removed.

## Resetting your device when the operating system is unresponsive

If you want to restore your device but cannot operate the touchscreen or the operating system is not responding to normal input, you may need to reset the device from the Boot Menu.

To reset from the Boot Menu:

1. Connect an external USB keypad to the device.
2. Press the Windows logo key  to get to the sign-in screen, then hold the **Shift** key down and select **Power / Restart** in the lower-right corner of the screen.
3. When the device restarts, tap **Troubleshoot / Reset this PC**.

If you cannot get to the sign-in screen, use a recovery drive or installation media to reset your device.

## Operating system and software updates

Periodically, operating system and software application updates will be available for your device.

### Windows 11 updates

The Windows 11 operating system periodically checks for updates so you don't have to. When an update is available, it is automatically downloaded and installed—keeping your device up-to-date with the latest features.

Installing the latest updates can help fix common issues, but you must be online to download the updates.

Once online, to check for and install the latest updates manually, go to **Settings / Update & security / Windows Update**, and select **Check for updates**. If **Windows Update** says your device is up to date, you have all the updates that are currently available.

Trimble recommends that you keep the Windows operating system updated. This reduces your vulnerability to cyber attacks, and helps to improve the Windows operating system. You can configure the settings to prevent downloads and restarts in the field; go to **Settings / Update & Security / Windows Update / Update Settings**.

For more information about Windows updates, refer to the official *Windows Update: FAQ* on [www.microsoft.com](http://www.microsoft.com).

### Software downloads and updates

The latest versions of software including drivers, firmware updates, and software utilities, are available on the [technical support pages](#) on [trimble.com](http://trimble.com).

## Repairing your device

Before you send your T10x tablet (2024) for repair, check the troubleshooting guide in this document. If you can't solve the problem with troubleshooting, contact your local Trimble dealer for further support.

Repair of this product should only be performed by an authorized service provider. Any attempt to disassemble this product by a non-authorized service provider will void the warranty.

For more information, contact your local Trimble dealer.

