

Trimble Access™ GENIO Roads

User Guide

Version 2025.20
Revision A
December 2025

Contents

1 Roads	3
2 GENIO roads	5
To export GENIO files from 12d Model	5
Viewing GENIO roads in the map	5
3 Defining a GENIO road	7
To define a GENIO road	7
To create or edit strings derived from other strings	9
To exclude the alignment at stakeout	10
To extract models from a 12da file	10
To review the definition of a GENIO road	11
String interpolation	13
4 Road navigation	15
Stakeout navigation display	19
5 Staking out a GENIO road	24
To start staking out a GENIO road	24
To stake out positions relative to a GENIO road	26
To stake out a position relative to a string in a GENIO road	27
To stake out a station on a string in a GENIO road	29
To stake out a position relative to a secondary road	30
Stake a position at a skew offset	32
Road stakeout options	33
6 Precise elevations	49
7 Reports	52
Roads stakeout reports	52
To generate a report	53
Legal information	54

Roads

The Trimble Access Roads software is a specialized application for surveying roads and similar linear objects.

The Roads software can be used to survey roads where the road design is defined in a road design file, or where you can build elements of a road (or other similar objects) by selecting one or two strings to stake relative to a primary stationing string. When staking one string you can also define a surface, if required.

When surveying with a road design file you can:

- Upload an existing road design consisting of an alignment with one or more related strings that define the road, or with related cross section templates.
Supported file types are RXL, LandXML and GENIO.
- Key in an RXL road design definition including horizontal and vertical alignments, templates, and superelevation and widening records.
- Review the road definition.
- Stake out the road.

When surveying using strings and surfaces or two polylines you can:

- Stake single strings relative to a primary stationing string, for example traffic islands or curbs. Or stake two strings relative to a primary stationing string, for example the top and bottom edge of an embankment or construction earthworks.
Strings can be lines, arcs or polylines that are keyed in to the job or they can be selected from any project data files that contain linework.
- Stake two polylines where you want station and offset and cut/fill to both polylines at the same time.

Generate a report for the as-staked road data to check data in the field, or to transfer data from the field to your client or to the office for further processing with office software.

Using the Roads app

To use Roads, you must switch to the Roads app. To switch between applications, tap  and tap the name of the app you are currently using, and then select the application to switch to.

TIP – The Roads app includes the full **Cogo** menu from General Survey so that you can carry out coordinate geometry (cogo) functions without having to switch to General Survey. You can also access some of these cogo functions from the tap and hold menu in the map. For information on all available cogo functions, refer to the *Trimble Access General Survey User Guide*.

When starting a survey you are prompted to select the survey style you have configured for your equipment. To learn more about survey styles and related connection settings refer to the appropriate topics in the *Trimble Access Help*.

To customize the terminology used in the software, tap ☰ and select **Settings / Language**. Select:

- **Use railroad terminology** if you are surveying a railroad and wish to use railroad-specific terminology.
- **Use chainage distance terminology** to use the term **Chainage** instead of **Station** for the distance along the road.

GENIO roads

GENIO files that define a road can be exported from a number of third party road design software packages, including Bentley MXROAD and 12d Model.

The file extension for the GENIO file must be *.crd, *.inp, or *.mos.

You can also use the Trimble Access Roads software to create a GENIO .inp file that contains models extracted from a .12da file. This is particularly useful if you are not able to export GENIO files from the 12d Model software.

To export GENIO files from 12d Model



TIP – You can use the Trimble Access Roads software to create a GENIO .mos file that contains models extracted from a .12da file. See [To extract models from a 12da file](#).

Use the steps below to export a road as a GENIO file from 12d Model:

1. Start 12d Model and select a project.
2. Select **File I/O / Data output – GENIO**.
3. From the **Write GENIO File for** dialog, select the alignment string as the data to write.
4. Enter a file name.
5. Set the **Alignment dimension** field to 6D.
6. Select the **77 Format** check box.
7. Write the file but do not select **Finish**.
8. Select the remaining strings that define the road as the data to write. Use the filter option to aid string selection.
9. Retain the file name used to write the alignment string.
10. Set the **Alignment dimension** field to 3D.
11. Write the file and then select **Yes** to append to the end of the existing file.
12. Select **Finish**.

Viewing GENIO roads in the map

In the map, a GENIO road is shown shaded in gray with the alignment shown as a red line.

If the road is not shown in the map, tap  to open the **Layer manager** and select the **Project data** tab. Select the GENIO file to see the list of available alignments in the file. Tap the name of the alignment you want to define the road to make it selectable  in the map. Tap **Accept** to return to the map.

In the map, tap the alignment to select the road. The road is highlighted in yellow with the alignment shown as a blue line. When you select a road, the **Review**, **Edit**, and **Stakeout** softkeys appear, enabling you to review or edit the road definition, or to stake out the road.

TIP - If the road is shown as a color gradient and you would prefer to view it in yellow, in the map toolbar tap  / **Settings** and clear the **Display color gradient** check box in the **Surface** group box.

NOTE - For a GENIO road that is not yet completely defined, only the alignment is shown in the map. When you tap the string to select it, the **Define** and **Stakeout** softkeys are available. Tap **Define** to add the strings to the road and complete the road definition. Tap **Stakeout** to stake the alignment.

To show or hide roads or other project data files in the map, tap  to open the **Layer manager** and select the **Project data** tab. Tap a file to make it visible or to hide it. This is useful for reviewing a road relative to related secondary roads, particularly at interchanges and intersections.

Defining a GENIO road



A GENIO file consists of a number of strings that define the geometry of the roads in the file. When you define a road you select the appropriate strings from the GENIO file. The road name and the names of the selected strings are saved as a comment to the end of the GENIO file.

NOTE - Because GENIO files do not include the units for the values in the file, you must configure the appropriate units for the GENIO file you are working with in the job.

To define a GENIO road

To define a road you must select the GENIO file and then select the strings in the GENIO file to include in the new road definition.

To select the GENIO file from the map

1. Tap  in the map toolbar to open the **Layer manager** and select the **Project data** tab.
2. Select the GENIO file to see the list of available alignments in the file. To make the string visible in the map, tap the name of the alignment you want to define the road and then tap it again to make it selectable  in the map. Tap **Accept**.
3. From the map, tap the alignment to select it and then tap **Define** to define a new GENIO road. The **Create new GENIO road** screen appears. To continue, see [To define the new road](#) below.

To select the GENIO file from the menu

1. Tap  and select **Define**.
 2. Select **GENIO road**.
 3. In the **Select GENIO file** screen, select the GENIO file. The file must be in the current project folder.
 4. Tap **Edit**.
 5. Tap **New**.
- The **Create new GENIO road** screen appears. To continue, see [To define the new road](#) below.

To define the new road

1. In the **Create new GENIO road** screen, enter the road name. Tap **OK**.
The software shows all the strings in the selected file.
2. Tap the strings you want to add to the road. To select multiple strings, drag a box around them.
Selected alignments are shown as solid red circles. Selected strings are shown as solid blue circles.

TIP –

- To pan around the screen, use the softkeys or tap and hold the pan softkey to make it active and then press the arrow keys.
- To see your current position when defining a road, start a survey.
- To deselect a string, tap it again. To clear your current selection, from the tap and hold menu select **Clear selection**.

3. To select strings from a list, tap and hold on the screen and then select **List selection**. Tap string names to select them. Selected strings appear in the list with a check mark next to them.
To change the string type or to rename a string, tap **Edit**. Although string names in GENIO files are limited to four characters, this limitation does not apply when you rename it in Trimble Access.
4. Tap **Accept**.
5. Tap **Store**.

NOTE –

- A road can include only one alignment (6D string). If the GENIO file does not include a 6D string but does include a 12D string, then the Roads software will generate a 6D string with the same geometry as the 12D string and positions every 5 meters / feet.
- Where available, Trimble recommends that you include the 12D string that is coincident with the selected alignment in the road. 12D strings include the geometry for the vertical alignment that enables the Roads software to correctly interpolate elevations between positions along the alignment.
- If a road includes a 12D string or if there is a 12D string in the GENIO file that is related to the 6D string in the road the station values in the 12D string that define the horizontal alignment are suffixed with their appropriate acronyms. For example, PC for the start of a curve.
- Because the station values for 3D and 5D strings are defined relative to the selected 6D string, select strings that obviously define a road.
- If required, you can exclude the alignment at stakeout. See [To exclude the alignment at stakeout, page 10](#).
- Unselected alignments appear as hollow red circles. Unselected strings (3D and 5D) appear as hollow dark gray circles.
- Tap and hold on a string to browse the string name. For an alignment (6D string) the station range is also displayed.
- To define a new 3D string, tap and hold on the screen and then select **New string**. This option is not available until you have selected an alignment (6D string).

To create or edit strings derived from other strings

If required, you can define a new string derived from an existing string in the GENIO file. You can then edit or delete strings derived from existing strings, as required, from the tap and hold menu.

To define a new string, you must have selected an alignment in the new GENIO road. New strings are created as 3D strings.

1. Select a GENIO file and define a new road or select an existing road and tap **Edit**.
2. From the tap and hold menu, select **New string**.
3. Enter the string name.
4. Select the string that the new string will be derived from. You cannot define a new string relative to a 5D string.
5. Select a string derivation method and then enter values that define the new string.

The following figure illustrates the **Offset and calculated slope** method where the **Derived from** string (1), the **Offset** value (2) and the **Calculated from** string (3) define a new string (4) on the slope between the **Derived from** and **Calculated from** strings.

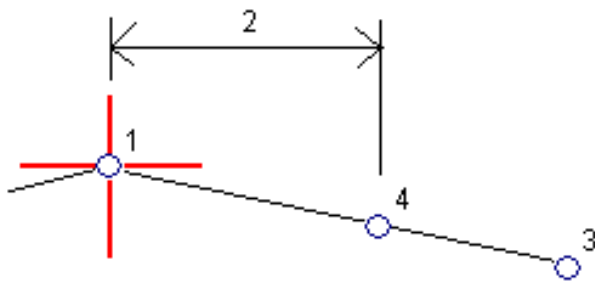

6. Tap **Accept**.

The new string appears, colored teal.

NOTE - When you define a new string by the **Offset and calculated slope** method, the new string is defined only where the station values for the **Derived from** and **Calculated from** strings match.

To exclude the alignment at stakeout

If the alignment has a vertical geometry that is unrelated to the road design, you can exclude this string. To do this, when defining the GENIO road, tap and hold on the screen and select **Exclude alignment at stakeout**.

The alignment is still part of the road and is used to calculate the station values at stakeout.

At stakeout, the alignment appears grayed out in the plan view and does not appear in the cross section view. The alignment is not available from the string selection list.

NOTE - To make sure that the alignment is available at stakeout, deselect **Exclude alignment at stakeout**.

To extract models from a 12da file

You can use the Trimble Access Roads software to create a GENIO .mos file that contains models extracted from a .12da file. This is particularly useful if you are not able to export GENIO files from the 12d Model software.

TIP - If the .12da file has been exported from the 12d Model software as a zipped file, it has the file extension .12daz. To extract the .12da file so you can use it in Trimble Access, in File Explorer change the extension of the .12daz file to .zip and then use WinZip to extract the file.

NOTE – The conversion from .12da files to GENIO files is not available when using Trimble Access on a Trimble controller running Android. In that case, use the 12da file to GENIO road converter for Trimble Access utility, which can be downloaded from the [Software and utilities page](#) of the Trimble Field Systems Help Portal.

1. Tap  and select **Define**.
2. Select **GENIO road**.
3. In the **Select GENIO file** screen, tap **12da**.

TIP – Alternatively, tap  in the map toolbar to open the **Layer manager**, select the **Project data** tab and then tap **12da**. This option is available only when Roads is the currently selected application.

4. Tap  to browse to the location of the 12da file and select it. Tap **Accept**.
5. In the conversion utility window, select the models (layers) containing road strings that you want to include in the new GENIO file.

You must select **at least one** model that contains an **alignment**. Models containing alignments are colored red.

NOTE –

- The Roads software requires each road defined from a GENIO file to include an alignment (6D string). If the model(s) selected do not include a 6D string but do include a 12D string then the conversion utility will generate a 6D string with the same geometry as the 12D string and with computed positions every 5 meters or feet. However for arcs with small radii the computed positions are based on an arc to chord separation of a maximum of 10 mm to ensure that the road is accurately represented.
- The conversion utility converts 3D strings that have names starting with **INT** or **IA** to 5D interface strings in the GENIO file.
- If there are duplicate 6D string names, the duplicates are given an incrementing suffix, ie. -1, -2, -3...

6. Tap **OK**.
7. Enter the name of the new file and tap **OK**.
The new GENIO file is listed in the **Select GENIO file** screen.
8. Define the GENIO road from the new GENIO file. See [To define a GENIO road](#).

To review the definition of a GENIO road

You can review the definition of a road at any time. View the road in 3D to visually confirm the road definition and to visualize the road relative to other road definitions, such as a complex interchange or urban intersection.

1. In the map, tap the road.

2. Tap **Review**.

Black hollow circles represent any portion of the horizontal alignment that has no elevations and so is drawn on the ground plane.

TIP - To move the ground plane closer to the road, tap  and select **Settings** and then edit the ground plane elevation.

Black solid circles represent the positions on the strings at each cross section.

Gray lines represent the strings and connect the cross sections.

3. Tap a string or a station on a string.

Alternatively, tap the **String** softkey to select a string from the list. The list shows only the strings that are at the start station or, if you have a position, the strings at the cross section at your current position. When a string is selected, tap the **Station** softkey to select a station from the list.



Information about the selected item is shown alongside the map.

4. To select a different station or string, you can:

- Tap the station on a string.
- Tap the **Station** or **String** softkey to select a station or string from a list.
- Press the up or down arrow key to select another station, or press the left or right arrow key to select another string.
- Tap the **Sta-** or **Sta+** softkey.

Use the map toolbar to navigate around the map and to change between views.

5. To view available cross sections, tap . Alternatively, assign the **Toggle Plan / Cross section** function to a function key on the controller so that you can switch between the plan and cross section views when reviewing and staking a road.



By default, each cross section is displayed so that it fills the screen, providing the best view of the cross section. To view cross sections relative to each other, tap the **Fixed scale** button  so that it changes to . Each cross section is displayed with the scale fixed so that the widest cross section fills the screen.

The alignment is shown as a red cross. The black circles represent the strings. The larger blue circle represents the currently selected string. The linework preceding the selected string is shown as a bold blue line. Information about the selected item is shown alongside the map.

To view the cross section at a different station, you can:

- Press the up or down arrow key.
- Tap **Station** to key in a station or to select a station from the list.

To select a different string, you can:

- Tap the string.
 - Press the left or right arrow key.
 - Tap **String** to select a string from the list.
6. To return to the plan of the road, tap  or press the **Tab** key.
 7. To view an automated 3D drive through of the road:
 - a. When viewing the plan or cross section in the map, tap **3D drive**.
 - b. Tap  to start the drive through.
 - c. To pause the drive through and inspect a particular part of the road, tap . To orbit the road while the drive through is paused, tap the screen and swipe in the direction to orbit.
 - d. To move forward and back along the road, press the up and down arrow keys.
 - e. To exit 3D drive, tap **Close**.
 8. To exit the road review, tap **Close**.

TIP – To review a position defined by a nominal station value, where the station does not have to coincide with a cross section, from the plan or cross section view tap **Station** and then key in a station value.

String interpolation

The following rules apply to keyed-in station values:

- For an alignment (6D string), the coordinates for keyed-in station positions are computed respecting the geometry of the string. Elevation values are computed by linear interpolation. However, if there is a 12D string coincident with the 6D string, the software uses the vertical alignment data available in the 12D string to compute the elevation values.
- For a 3D string, the offset and elevation values are interpolated from the offset and elevation values of the previous and next positions on that string. This ensures the integrity of the design, especially on tight curves. See the following example where the cross section at station 100 has a string offset from the 6D string by 3 and an elevation of 25. The next cross section at station 120 has a string offset by 5 and an elevation of 23. The position on the string for the interpolated station 110 is interpolated as shown to give an offset of 4 and an elevation of 24.

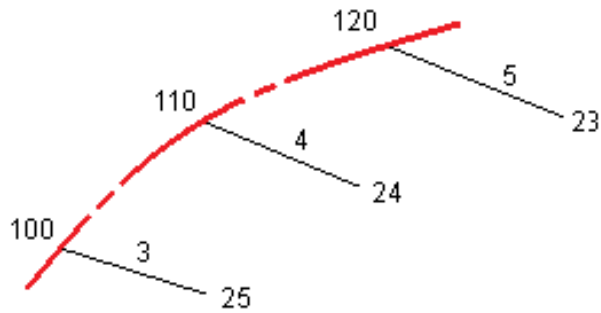

However, if the deflection angle of the 3D string compared to that of the associated 6D string is greater than 30 minutes, the geometry of the associated 6D string will be ignored and the coordinates will be computed by linear interpolation instead. This is to avoid unexpected behavior when there is an acute change in direction in the 3D string for features such as slip lanes, bus bays, and so on.

- Interpolation between points along a transition is calculated using a clothoid spiral for 12D and 6D strings and approximated for 3D strings.

When measuring your position relative to a GENIO road or where your station and offset are nominal values your position is computed by linear interpolation from the nearest positions on adjacent strings.

In all situations where your position is interpolated, closer station intervals give greater accuracy.

Road navigation

During stakeout or when reviewing the road, the left of the screen shows the road in the map or cross section view.

The panel to the right of the **Review** screen shows information about the part of the road you have selected in the map or cross section view.

The panel to the right of the **Stakeout** navigation screen shows the navigation pane.

- The arrow points in the direction of the point that you intend to measure (the "target").
- The stakeout delta values at the bottom of the navigation pane indicate the distance to and the direction of the target.

When navigating to a point during stakeout, the information shown depends on whether you are performing a Conventional or GNSS survey, and the options you have configured in the **Stakeout options** screen.

- To change the displayed deltas during stakeout, tap **Options** in the stakeout navigation screen or tap and hold in the navigation pane. For more information, refer to the topic **Stakeout navigation deltas** in the Trimble Access General Survey User Guide.
- To view the as-staked point details before you store the point, enable the **View before storage** setting. For more information, refer to the topic **As-staked point details** in the Trimble Access General Survey User Guide.

Map and cross section view

The stakeout navigation screen shows the map view or cross section view of the road.

Map

The map shows:

- Horizontal alignment as a red line
- Other strings as black lines
- Construction offsets as green lines
- Skew offsets as dashed black lines

During stakeout the map shows a dashed green line drawn from the current position to the:

- horizontal alignment when measuring your position relative to the road and you are within 30 m of the alignment/string
- selected string when measuring your position relative to a string and you are within 5 m of the string



Cross section view

To view the cross section of the road, tap  in the map toolbar.

When viewing a road design file:

- The cross section view shows the strings and templates relative to the alignment. It also shows any surface added as well as the surface calculated from the road design.
- The cross section is orientated in the direction of increasing station. Your current position and the target are shown. If the target has construction offsets specified, the smaller single circle indicates the selected position and the double circle indicates the selected position adjusted for the specified construction offset(s). The construction offset(s) appear as green lines.
- The appropriate cut or fill side slope appears for the side of the road that you are currently on.

NOTE – If you have set the **Design cut/fill** field to **Perpendicular** in the **Stakeout options** screen, the perpendicular cut/fill position is drawn on the design in the cross section view only when measuring positions relative to the road. Because the cross section view is not drawn to scale, the perpendicular position may appear slightly incorrect (ie. not exactly perpendicular).

- Tap and hold in the cross section view to define a [cross slope](#) or [subgrade](#).
- To step through the templates for the road, tap the arrow keys. To set a fixed scale based on the widest template in the road, tap . To use a variable scale so that each template fills the cross section view, tap .

When viewing strings and surfaces:

- Strings have no relationships to each other until you select them.
- The cross section view shows only the surface used – it cannot show any calculated surface.

To return to the map, tap .

TIP – Assign the **Toggle Plan / Cross section** function to a function key on the controller so that you can switch between the plan and cross section views when reviewing and staking a road.

Navigation pane

Before stakeout the software shows:

- Station (when staking a station on a string)
- String name (when staking a station on a string or measuring your position relative to a string)
For an RXL road, the software uses the string name from the template definition. When the offset is 0.000 m, the string name defaults to CL.
- Design elevation of the selected position (shown in red if edited)
- Construction offsets

- When staking a station on a string, the software also shows:
 - Type
 - Offset
 - Elevation (shown in red if edited)
- When staking a side slope, the software also shows the:
 - Design side slope values
 - Cut ditch width (RXL roads only)
- When staking a skew offset, the software also shows the:
 - Skew offset
 - Deflection angle/azimuth

During stakeout the software shows:

- Elevation of your current position (shown in blue)
- When staking a side slope, the software also shows:
 - Side slope value defined by your current position (shown in blue)
 - Design side slope value (shown in red if edited)
- **Off road** appears if your current position is before the start of the road or beyond the end of the road.
- **Undefined** appears when consecutive horizontal alignment elements are non tangential and your current position is beyond the end tangent point of the incoming element but before the start tangent point of the next element and you are on the outside of the road. See position 1 in the diagram below.
- When consecutive horizontal alignment elements are non tangential and your current position is before the end tangent point of the incoming element but after the start tangent point of the next element, and your position is on the inside of the road (see position 2 in the diagram below), the station, offset and vertical distance values are reported using the closest horizontal element to your position to determine which portion of the road to use.

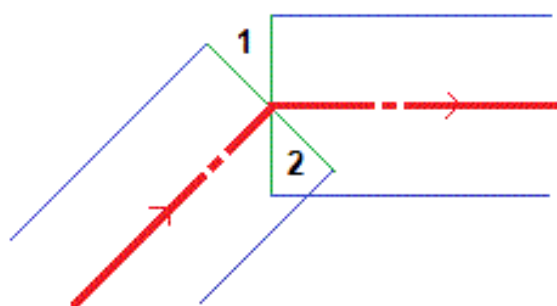

Consider the following diagram:

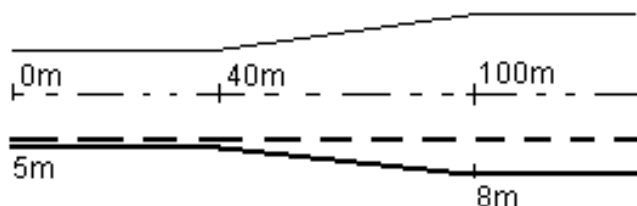

If you select an offset/string that has an offset value of 5 m, the offset value updates to follow the solid line for subsequent stations. In this example, the offset changes from 5 m to 8 m between stations 40 m and 100 m and then is maintained at 8 m for subsequent stations.

If you key in 5 m for the offset, the offset follows the dashed line. That is, the offset of 5 m is maintained for subsequent stations.

GNSS tilt sensor information

When using a GNSS receiver with a built-in tilt sensor, you can:

- Tap **eBubble** to display an electronic bubble
- Configure the survey style to prompt a warning when the pole is outside a specified **Tilt tolerance**
- To configure quality control, precision, and tilt settings, tap **Options**.

Stakeout navigation display

The information shown when navigating to points during stakeout depends on whether you are performing a Conventional or GNSS survey, and the options you have configured in the **Stakeout options** screen.

To configure these options:

- In the survey style, tap **☰** and select **Settings / Survey styles / <Style name> / Stakeout**.
- During stakeout, tap **Options** in the stakeout navigation screen.

Conventional surveys

Use the **Display** group to configure the appearance of the navigation display during stakeout:

- To show the large navigation arrow in the navigation screen, set the **Show stakeout graphics** switch to **Yes**.

TIP – If you are using a controller with a smaller screen, or you want to fit more navigation deltas on the screen, set the **Show stakeout graphics** switch to **No**. The other fields in the **Display** group are hidden when the switch is set to **No**.

- Select the **Display mode**: The options are:
 - **Direction and distance** – the stakeout navigation display shows a large arrow pointing in the direction you have to move. When you are close to the point, the arrow changes to the in/out and left/right directions, relative to the instrument.
 - **In/out and left/right** – the stakeout navigation display shows in/out and left/right directions.



TIP – By default the software automatically gives in/out and left/right directions from the **Target perspective** in a robotic survey, and from the **Instrument perspective** when connected to a servo instrument using a face plate or cable. To change this, change the settings in the **Servo/Robotic** group box. For more information, refer to the topic **Instrument configuration** in the *Trimble Access General Survey User Guide*.

- Use the **Distance tolerance** field to specify the allowable error in distance. If the target is within this distance from the point, the software indicates that the distance is correct.
- Use the **Angle tolerance** field to specify the allowable error in angle. If the conventional instrument is turned away from the point by less than this angle, the software indicates that the angle is correct.
- Use the **Grade** field to display the grade of a slope as an angle, percent, or ratio. The ratio can be displayed as **Rise:Run** or **Run:Rise**.
- When staking position relative to a road, from the **Design cut/fill** field, select whether to show the **Vertical** or **Perpendicular** cut/fill to the design.

NOTE – The **Perpendicular** cut/fill position is drawn on the design in the cross section view. Because the cross section view is not drawn to scale, the perpendicular position may appear slightly incorrect (ie. not exactly perpendicular).

TIP – For all other stakeout methods the **Vertical** cut/fill to the design is always shown.

- In the **Deltas** group, review the deltas shown for the current stakeout item. To change the deltas shown, tap **Edit**.
Deltas are the information fields shown during navigation that indicate the direction and distance you need to travel to the item you want to stake out. For more information, refer to the topic **Stakeout navigation deltas** in the *Trimble Access General Survey User Guide*.
- To display the cut or fill relative to a surface during stakeout, enable the **Cut/Fill to surface** switch.
 - a. In the **Surface** field, select the surface file from the current project folder. Only surface files that are set to visible or selectable in the **Layer manager** are listed.

Alternatively, in the map select surfaces from BIM files. If you cannot select surfaces in the map, make sure the BIM file is set to selectable in the **Layer manager**. If the **Selection mode** button  on the **BIM** toolbar is button is yellow , tap it and select **Surface selection - Individual faces** mode.

NOTE – You can select **Surface selection - Whole object** mode, but when using **Whole object** mode the software selects both the top and bottom surface and calculates the cut/fill to whichever surface you are closest to.

The **Surface** field indicates the number of surfaces you have selected in the map.

To select a different surface from the map, double-tap in the map to clear the current selection and then select the new surface.

- b. If required, in the **Offset to surface** field, specify an offset to the surface. Tap  to select whether the offset is to be applied vertical or perpendicular to the surface.
 - c. To show the distance to the surface in the stakeout navigation screen, tap **Options**. In the **Deltas** group box, tap **Edit** and select the **V. Dist surface at current position** or the **Perp. Dist to surface at current position** delta. Tap **Accept**.
- If your Trimble controller includes an internal compass, you can use it when staking out a position or navigating to a point. To use the internal compass, select the **Compass** check box. Trimble recommends you **disable** the compass when you are near magnetic fields that may cause interference.

GNSS surveys

Use the **Display** group to configure the appearance of the navigation display during stakeout:

- To show the large navigation arrow in the navigation screen, set the **Show stakeout graphics** switch to **Yes**.

TIP – If you are using a controller with a smaller screen, or you want to fit more navigation deltas on the screen, set the **Show stakeout graphics** switch to **No**. The other fields in the **Display** group are hidden when the switch is set to **No**.

- Select the **Display mode**: The options are:
 - **Target centered** – the selected point stays fixed in the center of the screen
 - **Surveyor centered** – your position stays fixed in the center of the screen
- Choose a setting in the **Display orientation** field. The options are:
 - **Direction of travel** – the screen will orientate so that the top of the screen points in the direction of travel.
 - **North / Sun** – the small orientation arrow shows the location of North or the sun. The screen will orientate so that the top of the screen points toward North or the sun. When using the display, tap the **North/Sun** softkey to toggle the orientation between north and the sun.

- **Reference azimuth:**
 - For a point the screen will orientate to the **Reference azimuth** for the job. The **Stake** option must be set to **Relative to azimuth**.
 - For a line or road the screen will orientate to the azimuth of the line or road.

NOTE – If, when staking a point, the **Display orientation** is set to **Reference azimuth** and the **Stake** option is **not** set to **Relative to azimuth** the display orientation behavior will default to **Direction of travel**.

- Use the **Grade** field to display the grade of a slope as an angle, percent, or ratio. The ratio can be displayed as **Rise:Run** or **Run:Rise**.
- When staking positions relative to a road, from the **Design cut/fill** field, select whether to show the **Vertical** or **Perpendicular** cut/fill to the design.



NOTE – The **Perpendicular** cut/fill position is drawn on the design in the cross section view. Because the cross section view is not drawn to scale, the perpendicular position may appear slightly incorrect (ie. not exactly perpendicular).

TIP – For all other stakeout methods the **Vertical** cut/fill to the design is always shown.

- In the **Deltas** group, review the deltas shown for the current stakeout item. To change the deltas shown, tap **Edit**.

Deltas are the information fields shown during navigation that indicate the direction and distance you need to travel to the item you want to stake out. For more information, refer to the topic **Stakeout navigation deltas** in the *Trimble Access General Survey User Guide*.

- To display the cut or fill relative to a surface during stakeout, enable the **Cut/Fill to surface** switch.
 - a. In the **Surface** field, select the surface file from the current project folder. Only surface files that are set to visible or selectable in the **Layer manager** are listed.

Alternatively, in the map select surfaces from BIM files. If you cannot select surfaces in the map, make sure the BIM file is set to selectable in the **Layer manager**. If the **Selection mode** button  on the **BIM** toolbar is button is yellow , tap it and select **Surface selection - Individual faces** mode.

NOTE – You can select **Surface selection - Whole object** mode, but when using **Whole object** mode the software selects both the top and bottom surface and calculates the cut/fill to whichever surface you are closest to.

The **Surface** field indicates the number of surfaces you have selected in the map.

To select a different surface from the map, double-tap in the map to clear the current selection and then select the new surface.

- b. If required, in the **Offset to surface** field, specify an offset to the surface. Tap  to select whether the offset is to be applied vertical or perpendicular to the surface.
 - c. To show the distance to the surface in the stakeout navigation screen, tap **Options**. In the **Deltas** group box, tap **Edit** and select the **V. Dist surface at current position** or the **Perp. Dist to surface at current position** delta. Tap **Accept**.
- If your Trimble controller includes an internal compass, you can use it when staking out a position or navigating to a point. To use the internal compass, select the **Compass** check box. Trimble recommends you **disable** the compass when you are near magnetic fields that may cause interference.

NOTE – If you are using IMU tilt compensation and the IMU is aligned, the heading from the receiver is always used to orient the GNSS cursor, the large stakeout navigation arrow and the close up screen. You must be facing the LED panel of the receiver for these to be orientated correctly.

By default the software displays navigation information to the point from your current position. To navigate using a cross-track line between the point to be staked out and a reference point, change the **Stake** method. For more information, refer to the topic **GNSS stake methods** in the *Trimble Access General Survey User Guide*.

Staking out a GENIO road

When staking out a GENIO road, you can work from the map or from the menu.

If you select the road in the map and then tap **Stakeout**, the software always shows the plan view of the road. Select the item in the road to stake. From the plan view you can switch to the [cross section view](#) when required.

If you work from the menu, tap  and select **Stakeout / Stakeout roads** and then select the road to stake out.

If you have chosen to [exclude the alignment at stakeout](#), the alignment appears grayed out in the plan view and does not appear in the cross section view. To stake it out, return to **Define** and from the tap and hold menu select **Exclude alignment at stakeout**.

When you open a GENIO road, the software calculates the station values for all 3D strings relative to the alignment (6D string) for the road.

The software interpolates elevation values along the string. For more information, see [String interpolation, page 13](#).

By default, the software converts all 5D strings to side slopes. However, if the road includes multiple side slopes that define benched side slopes, only the 5D / Interface string that is furthest from the alignment is converted to a side slope.

To configure the software to treat 5D strings as 3D strings, in the **Stakeout options** screen clear the **Auto side slope** check box. To view the **Stakeout options** screen, tap **Options** in the screen where you enter the **Antenna height** or **Target height**.

For GENIO files defined from 12d Model, Roads treats all strings with a name that includes the letters INT as a 5D string and converts the string to a side slope, unless you have cleared the **Auto side slope** check box in the **Stakeout options** screen. The calculated slope value is defined by the slope between the interface string and the adjacent 3D string.

To start staking out a GENIO road

When staking out a GENIO road, you can work from the map or from the menu.

CAUTION – Do not change the coordinate system or calibration after you have staked out points, or computed offset or intersection points. If you do, the previously staked out or computed points will be inconsistent with the new coordinate system and any points computed or staked out after the change.

From the map

1. In the map, tap the road.

If the road you want to stake out is not shown in the map, tap  in the map toolbar to open the **Layer manager** and select the **Project data** tab. Select the file and then make the appropriate layer (s) visible and selectable. The file must be in the current project folder.

TIP – Instead of selecting a defined road you can define it now when you need it ("on the fly"). See [To define a GENIO road](#).

2. Tap **Stakeout**.

If you have not yet started a survey, the software prompts you through the steps to start the survey.

3. Enter a value in the **Antenna height** or **Target height** field and make sure that the **Measured to** field is set correctly.
4. Enable the **Cut/Fill to surface** switch.
 - a. In the **Surface** field, select the surface file from the current project folder.
 - b. If required, in the **Offset to surface** field, specify an offset to the surface. Tap  to select whether the offset is to be applied vertical or perpendicular to the surface.
 - c. To show the distance to the surface in the stakeout navigation screen, tap **Options**. In the **Deltas** group box, tap **Edit** and select the **V. Dist surface at current position** or the **Perp. Dist to surface at current position** delta. Tap **Accept**.
5. Tap **Options** to configure preferences for **Grade**, **As-staked point details**, **Display** and **Available stations**.
6. Tap **Next**.
The plan view of the road appears.
7. Select the item to stake out. For the next steps, refer to the topic for the appropriate stakeout method.

Once the position has been measured and stored, the software returns to either the navigation screen where you can select the next point on the road/string, or to the plan screen where you can select a different stakeout method.

From the menu

1. Tap  and select **Stakeout**.
2. Tap **Stakeout roads**.
3. If you have not yet started a survey, the software prompts you through the steps to start the survey.
4. In the **Select file** screen, select the GENIO file. The file must be in the current project folder.

TIP - To configure the software to display the road selection screen instead of the map when you measure and store a position, tap **Options** and select the **Display the road selection screen on escape** check box.

5. Tap **Next**.
6. Select the road to stake out. Tap **Next**.
7. Enter a value in the **Antenna height** or **Target height** field and make sure that the **Measured to** field is set correctly.
8. Enable the **Cut/Fill to surface** switch.
 - a. In the **Surface** field, select the surface file from the current project folder.
 - b. If required, in the **Offset to surface** field, specify an offset to the surface. Tap **▸** to select whether the offset is to be applied vertical or perpendicular to the surface.
 - c. To show the distance to the surface in the stakeout navigation screen, tap **Options**. In the **Deltas** group box, tap **Edit** and select the **V. Dist surface at current position** or the **Perp. Dist to surface at current position** delta. Tap **Accept**.
9. Tap **Options** to configure preferences for **Grade, As-staked point details, Display** and **Available stations**.
10. Tap **Next**.
The plan view of the road appears.
11. Select the item to stake out. For the next steps, refer to the topic for the appropriate stakeout method.

Once the position has been measured and stored, the software returns to either the navigation screen where you can continue measuring points on the road/string, or to the plan screen where you can select the next position to stake or select a different stakeout method.

To stake out positions relative to a GENIO road

1. Start the survey and select the road to stake out.
If nothing is selected in the plan view, then by default you are ready to measure your position relative to the GENIO road.
2. To stake points offset from the road, leaving the roadway clear for construction, [define a construction offset](#).
3. To view the perpendicular cut/fill to the road, select **Options** and in the **Road** group box set the **Design cut/fill** field to **Perpendicular**.
4. Tap **Start**.
The [Road navigation, page 15](#) screen appears. Tap **Options** to configure preferences for the navigation display, grade, as-staked point details, or to [view stakeout deltas relative to a digital](#)

terrain model (DTM).

5. Use the information in the [Road navigation, page 15](#) screen to see your position relative to the road and navigate to the point to stake it out.

If your current position is:

- Within 30 m of the alignment, the plan view shows a dashed green line drawn at a right angle from your current position to the string.
- More than 30 meters from the alignment, the software navigates you to a position on the alignment. This is calculated by projecting your current position at right angles to the alignment.

6. When the point is within tolerance, tap **Measure** to measure the point.

When using a Trimble SX12 scanning total station in **TRK** mode with the *laser pointer enabled*, the **Stakeout** screen shows the **Mark point** softkey instead of the **Measure** softkey. Tap **Mark point** to put the instrument into **STD** mode. The laser pointer stops flashing and moves to position itself at the EDM location. When you tap **Accept** to store the point, the instrument automatically returns to **TRK** mode and the laser pointer resumes flashing. To remeasure and update the stakeout deltas, tap **Measure** after you tap **Mark point** and before you tap **Accept**.

Tap **Store**.

The software returns to the navigation screen.

7. Continue measuring points along the road.
8. To exit this stakeout method, tap **Esc**.

NOTE –

- To understand how your position is calculated between strings, see [String interpolation, page 13](#).
- If the road consists of only an alignment (6D string), the **V.Dist** value will report the vertical distance to this string.

To stake out a position relative to a string in a GENIO road

To stake out a position relative to a string on a GENIO road, start the survey and then:

1. Tap the linework that represents the string. The name of the selected string appears at the top of the screen.

To select a different string, use the left/right arrow keys. Alternatively, tap and hold in the plan view and select a string from the list. The strings in the list are determined by the templates assigned at your current position relative to the road.

2. To edit the elevation, from the tap and hold menu select **Edit elevation**. To reload an edited elevation, select **Reload original elevation**.
3. If required, add the following features:
 - To stake points offset from the road, leaving the roadway clear for construction, [define a construction offset](#).
 - To stake cut/fill catch positions, [define or edit a side slope](#).
 - To confirm the construction of the road surface, [define a cross slope](#).
4. Tap **Start**.
The [Road navigation, page 15](#) screen appears. Tap **Options** to configure preferences for the navigation display, grade, as-staked point details, or to [view stakeout deltas relative to a digital terrain model \(DTM\)](#).
5. Use the information in the [Road navigation, page 15](#) screen to see your position relative to the road and navigate to the point to stake it out.
If your current position is within 5 m of the selected string, the plan view shows a dashed green line drawn at a right angle from your current position to the string.
If you are staking a [catch point](#) (5D / Interface string) with construction offsets, navigate to the catch point and then tap **Apply** to add the construction offsets. You are prompted to apply the offsets from your current position. If you are not on the catch position, select **No**, navigate to the catch position and then tap **Apply** again. To store the catch position and the construction offset, see [Construction offsets](#).
6. When the point is within tolerance, tap **Measure** to measure the point.
When using a Trimble SX12 scanning total station in **TRK** mode with the *laser pointer enabled*, the **Stakeout** screen shows the **Mark point** softkey instead of the **Measure** softkey. Tap **Mark point** to put the instrument into **STD** mode. The laser pointer stops flashing and moves to position itself at the EDM location. When you tap **Accept** to store the point, the instrument automatically returns to **TRK** mode and the laser pointer resumes flashing. To remeasure and update the stakeout deltas, tap **Measure** after you tap **Mark point** and before you tap **Accept**.
Tap **Store**.
The software returns to the navigation screen.
7. Continue measuring points along the road.
8. To exit this stakeout method, tap **Esc**.

NOTE –

- If the string selected to stake is a 5D string Roads converts this string to a side slope. The calculated slope value is defined by the slope between the 5D string and the adjacent 3D string.
- For 5D / Interface strings, the target may not coincide with the design position because the target is calculated relative to your current position.

To stake out a station on a string in a GENIO road

To stake out a station on a string in a GENIO road, start the survey and then:

1. In the plan or cross section view, tap the station on the string.

To select a different position, use the left/right arrow keys to select a different string and the up/down arrow keys to select a different station.

To select the station from a list, from the tap and hold menu tap **Select string** and select the string and then from the tap and hold menu tap **Select station**.

To stake out a position defined by a nominal station, from the tap and hold menu tap **Select station** and in the **Station** a field enter a station value. For more information, see [String interpolation, page 13](#).
2. To edit the elevation, from the tap and hold menu select **Edit elevation**. To reload an edited elevation, select **Reload original elevation**.
3. If required, add the following features:
 - To stake points offset from the road, leaving the roadway clear for construction, [define a construction offset](#).
 - To stake cut/fill catch positions, [define or edit a side slope](#).
 - To confirm the construction of the road surface, [define a cross slope](#).
 - To stake points on surfaces other than the finished road surface, [define a subgrade](#).
4. Tap **Start**.

The [Road navigation, page 15](#) screen appears. Tap **Options** to configure preferences for the navigation display, grade, as-staked point details, or to [view stakeout deltas relative to a digital terrain model \(DTM\)](#).
5. Use the information in the [Road navigation, page 15](#) screen to see your position relative to the road and navigate to the point to stake it out.

If you are staking a [catch point](#) (5D / Interface string) with construction offsets, navigate to the catch point and then tap **Apply** to add the construction offsets. You are prompted to apply the offsets from your current position. If you are not on the catch position, select **No**, navigate to the catch position and then tap **Apply** again. To store the catch position and the construction offset, see [Construction offsets](#).
6. When the point is within tolerance, tap **Measure** to measure the point.

When using a Trimble SX12 scanning total station in **TRK** mode with the *laser pointer enabled*, the **Stakeout** screen shows the **Mark point** softkey instead of the **Measure** softkey. Tap **Mark point** to put the instrument into **STD** mode. The laser pointer stops flashing and moves to position itself at the EDM location. When you tap **Accept** to store the point, the instrument automatically returns to **TRK** mode and the laser pointer resumes flashing. To remeasure and update the stakeout deltas, tap **Measure** after you tap **Mark point** and before you tap **Accept**.

Tap **Store**.

The software returns to the selection screen.

- Continue selecting and measuring points along the road, or select a different stakeout method.

NOTE -

- For 5D / Interface strings, the target may not coincide with the design position because the target is calculated relative to your current position.
- If the string selected to stake is a 5D string Roads converts this string to a side slope. The calculated slope value is defined by the slope between the 5D string and the adjacent 3D string.

To stake out a position relative to a secondary road

The **Select secondary road** option enables you to reference stakeout details from a secondary road to a position being staked on the primary (current) road. This option is particularly useful when staking the median of a dual carriageway/divided highway. It enables a single stake to be positioned with the stakeout details for both the left and right edges of the median.

- Tap  and select **Stakeout**.
- Tap **Stakeout roads**.
- Select the GENIO file. Tap **Next**.
- Select the primary road. Tap **Next**.
- Enter a value in the **Antenna/Target height** field. Tap **Next**.

The primary road is displayed.

- Select the position to stake on the primary road. The position must be on a 3D string.
- From the tap and hold menu, tap **Select secondary road**.

In the plan view the secondary road is displayed.

NOTE - You may need to repeat step 6 after selecting the secondary road.

TIP - To deselect a secondary road, select a position on a 3D string and then from the tap and hold menu, select **Select secondary road** and then tap **None**.

8. To select the position to stake on the secondary road:

- a. Tap and hold in the plan or cross section view and select **View secondary cross section**.

The computed station value on the secondary road **(1)** of the selected position on the primary road **(2)**, along with the computed offset **(3)** from the selected position to the secondary road is displayed at the top of the screen:

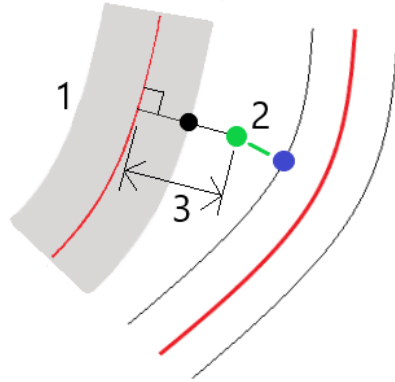

- b. The cross section for the secondary road **(1)** at the computed station is displayed along with the position selected to stake on the primary road **(2)**. Tap the line **(3)** preceding the position you want to stake on the secondary road:

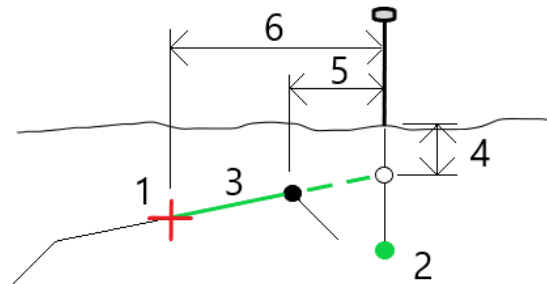

Stake details for the secondary road reported in the **Confirm staked deltas** screen include V.Distance to road **(4)**, Horizontal construction offset (calculated) **(5)** and Distance to alignment **(6)**.

9. Tap **Accept**.
10. Tap **Start**. Use the plan or cross section view to navigate to the point.
11. When the point is within tolerance, measure the point and mark up the stake with the deltas for the primary and secondary roads.

Stake a position at a skew offset

NOTE - This stakeout method can be used when staking from a **road design file**. It does not apply when staking **Strings and surfaces**.

Use the **Skew offset** stakeout method to stake out a position that is not defined at a right angle to the horizontal alignment, for example when staking culverts or bridge abutments.

The diagram below shows a point defined by skew forward and offset to the right. The point to stake (**1**) is defined from the station (**3**) by an offset (**5**) along the skew (**2**). The skew can be defined by a forward or backward delta angle to a line (**6**) at right angles to the road being staked (**4**) or, alternatively, the skew can be defined by an azimuth.

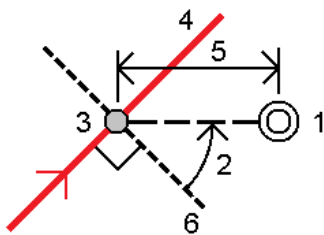

To stake out a position at a skew offset

1. In the stakeout selection screen, select **Skew offset** from the **Stake** field.
2. In the map, tap the station on the alignment that the skew offset will be applied from. Alternatively, tap  next to the **Station** field to select the station from the list.

TIP -

- To customize the stations available for stakeout, tap  next to the **Station** field to view the **Select station** screen. See [Stations available for stakeout, page 34](#).
- To stake out a skewed offset relative to a nominal station value (where the station does not have to coincide with a cross section), enter a nominal station value.

3. To define the skew offset:
 - a. Enter the **Offset** and **Skew** values. Tap  to change the offset or skew direction.
 - b. To define the elevation for the point, select:
 - **Slope from string** to compute the elevation by a slope from the elevation on the string at the selected station
 - **Delta from string** to compute the elevation by a delta from the elevation on the string at the selected station.

- **Key in** to key in the elevation.

If the road only has a horizontal alignment, you must key in the elevation.

c. Tap **Accept**.

4. To stake points offset from the road, leaving the roadway clear for construction, define a construction offset.

See [GENIO road construction offsets, page 37](#).

5. Tap **Start**.

The [Road navigation, page 15](#) screen appears. Tap **Options** to configure preferences for the navigation display, grade, as-staked point details, or to [view stakeout deltas relative to a digital terrain model \(DTM\)](#).

6. Use the information in the [Road navigation, page 15](#) screen to see your position relative to the road and navigate to the point to stake it out.

7. When the point is within tolerance, tap **Measure** to measure the point.

When using a Trimble SX12 scanning total station in **TRK** mode with the *laser pointer enabled*, the **Stakeout** screen shows the **Mark point** softkey instead of the **Measure** softkey. Tap **Mark point** to put the instrument into **STD** mode. The laser pointer stops flashing and moves to position itself at the EDM location. When you tap **Accept** to store the point, the instrument automatically returns to **TRK** mode and the laser pointer resumes flashing. To remeasure and update the stakeout deltas, tap **Measure** after you tap **Mark point** and before you tap **Accept**.

8. Tap **Store**.

The software returns to the navigation screen.

Next steps

- To continue measuring points along the road, tap the **Sta+** or **Sta-** softkey to select the next or previous station.

If you have enabled the **Auto increment** field in the **Select station** screen then the next or previous station is automatically selected. See [Stations available for stakeout, page 34](#).

- Tap **Esc** to exit this stakeout method.
- Change stakeout methods. To stake:
 - **To the road**, double-tap an empty part of the map.
 - **To a string**, tap the string in the map.
 - **A Station on a string**, tap the station on a string in the map.

Road stakeout options

Depending on the selected stakeout method, you can add more features to the road or edit existing features when staking out the road.

When staking from a road design file or from surfaces and strings:

- To customize the stations available for stakeout, see [Stations available for stakeout, page 34](#).
- To stake points offset from the road, leaving the roadway clear for construction, [define a construction offset](#).
- To view stakeout deltas relative to a surface, see [Additional stakeout deltas to a surface, page 40](#).

When staking from a road design file you can also:

- Navigate to and stake the catch point (the point where the design slope intersects with the ground). See [Catch point, page 41](#).
- Add or edit a side slope. See [Side slopes, page 43](#).
- Define a cross slope when you need to confirm the construction of a road surface. See [Cross slopes, page 46](#).
- Define a subgrade when the cross section represents the finished road surface and you need to stake the points defining other surfaces in the road. See [Subgrades, page 47](#).

Stations available for stakeout

You can customize the stations available for stakeout when using the following methods:

- Station on string (from a road design file or from strings and surfaces)
- Skew offset (from a road design file)

To customize the stations available, select the stakeout method and then tap  next to the **Station** field in the **Stakeout** screen. The **Select station** screen appears, listing the stations on the centerline.

Station interval settings

Select the station interval **Method**:

- The **Relative** method gives station values relative to the selected start station. Enter the station to start from in the **Relative to station** field and then enter the value for the **Station interval**. This is useful when:
 - The design starts at 0.00 but you want to configure the station interval settings from a station that is not the start station of the design. For example, enter 500.00 in the **Relative to station** field and then enter 30.00 in the **Station interval** field to produce stations at 500.00, 530.00, 560.00, 590.00, and so on.
 - The design starts at a value that is not 0.00. For example, if the start station is 2.50 and the station interval is 10.00, enter 2.50 in the **Relative to station** field and then enter 10.00 in the **Station interval** field to produce stations at 2.50, 12.50, 22.50, 32.50, and so on.
- The **0 based** method is the default method and gives station values that are multiples of the station interval, regardless of the start station. For example, if the start station is 2.50 and the station interval is 10.00, the 0 based method produces stations at 2.50, 10.00, 20.00, 30.00 and so on.

If required, edit the **Station interval for lines** and **Station interval for arcs and transitions** or accept the default value set when the road was defined. A separate station interval value for arcs and transitions enables you to tighten the interval for curves and more accurately represent the design on the ground.

TIP – If you have configured different values for the **Station interval for lines** and the **Station interval for arcs and transitions**, then the list of available stations may include stations at different intervals.

In the **Auto increment** field:

- Select **Sta+** to automate the selection of the *next* station for stakeout.
- Select **Sta-** to automate the selection of the *previous* station for stakeout.
- Select **No** if you want to manually select the next station to stake.

Selecting **Sta+** or **Sta-** in the **Auto increment** field provides a faster, more streamlined workflow.

NOTE – **Station interval** settings (including **Method** and **Auto increment** settings) configured in the **Select station** screen are written to the road file so that the same settings are used if the file is shared with other survey crews. If the file is an **IFC file**, the **Station interval** settings are written to a **Trimble Additional Properties (TAP)** file. The TAP file is stored in the same folder as the IFC file of the same name. If other survey crews are using the IFC file, then you must share the .tap file with the .ifc file to ensure all survey crews use the same settings.

Available stations

To configure the types of stations shown in the station list, select the appropriate **Available Stations** check boxes.

Depending on the road type, you can select the following:

- **Computed Sections defined by the station interval**
- **Horizontal Curve** (key stations defined by the horizontal alignment)
- **Vertical Curve** (key stations defined by the vertical alignment)
- **Template** (stations where templates have been assigned)
- **Super/Widen** (stations where superelevation and widening has been assigned)

The station abbreviations used in the Roads software are:

Station type	Abbreviation	Meaning
Start/end	S	Start station
	E	End station
Computed sections	CXS	Computed sections defined by the station interval

Station type	Abbreviation	Meaning
Vertical curve	VCS	Vertical curve start
	VCE	Vertical curve end
	VPI	Vertical point of intersection
	Hi	Vertical curve high point
	Lo	Vertical curve low point
Superelevation/Widening	SES	Superelevation start
	SEM	Superelevation maximum
	SEE	Superelevation end
	WS	Widening start
	WM	Widening maximum
	WE	Widening end
Horizontal curve	PI	Point of intersection
	PT	Point of tangent (Curve to tangent)
	PC	Point of curvature (Tangent to curve)
	TS	Tangent to transition
	ST	Transition to tangent
	SS	Transition to transition
	CS	Curve to transition
	SC	Transition to curve
Template assignment	T	Template assignment
Other	DXS	Design sections defined by the positions in the file
	STEQ	Station equation

GENIO road construction offsets

To stake positions offset from a GENIO road, leaving the roadway clear for construction, define one or more construction offsets for the road. The construction offset is applied to all positions in the road.

In the plan or cross section view, a construction offset is indicated by a dashed green line, and a solid green circle indicates the selected position adjusted for the construction offsets.

When you define a construction offset for a road, the offset is:

- used for all roads of the same file format in the same job.
- used for all subsequent surveys of the road in the same job, until a different construction offset is defined.
- not used for the same road when it accessed from a different job.

To define a construction offset, tap and hold in the plan view or cross section view and select **Define construction offsets**.

Horizontal construction offsets

When staking to a string or when staking stations on a string, you can define a horizontal construction offset where:

- A negative value offsets points to the left of the horizontal alignment.
- A positive value offsets points to the right of the horizontal alignment.

For all other strings, including side slope strings, you can define a horizontal construction offset where:

- A negative value offsets points toward the horizontal alignment (in).
- A positive value offsets points away from the horizontal alignment (out).

NOTE – When staking a side slope with construction offsets where you wish to store a position at the catch and the offset position, select the **Store both catch and construction offset** check box when defining the construction offset. See [Catch point](#).

When staking stations on a string, tap  next to the **Horizontal offset** field to specify if the offset is to be applied:

- Horizontally
- At the slope of the line from the previous string to the current string in the cross section
- At the slope of the line from the current string to the next string in the cross section

The following diagram shows a **Horizontal offset (1)**, **Slope previous offset (2)** and **Slope next offset (3)** applied to a position. For the **Slope previous** option, the slope of the offset is defined by the slope of the line (4) before the position (5) selected to stake. For the **Slope next** option, the slope of the offset is defined by the slope of the line (4) after the position (6) selected to stake. The **Vertical offset** value in the diagram is 0.000.

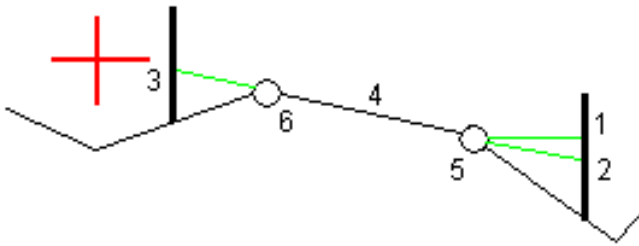

NOTE – For points with zero offset, you cannot apply horizontal construction offsets at the slope value of the previous line.

For a GENIO road, tap  next to the **Horizontal offset** field to specify if the offset is to be applied:

- Perpendicular to the alignment for the string being staked
- Perpendicular to the string being staked

The following diagram shows a **Horizontal offset (1)** applied perpendicular to the alignment string **(2)** and a **Horizontal offset (3)** applied perpendicular to the string **(4)**.

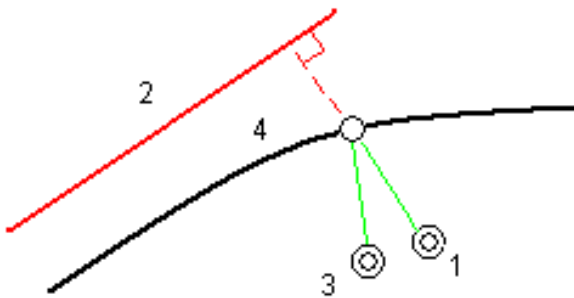

When staking stations on a string, you can define a horizontal offset by the distance from the selected position to the alignment. To do this:

1. Tap  next to the **Horizontal offset** field and select **To alignment**.
2. Navigate to the target which will be at the alignment.
3. Measure and store the point.

The calculated horizontal offset is reported in the **As staked deltas**.

This option is not available if the string being staked is a 5D string or if the horizontal offset is applied perpendicular to the string.

When measuring positions relative to a string or a station on a string, you can define a horizontal offset by the distance from the selected position to your current position. To do this:

1. Tap  next to the **Horizontal offset** field and select **Calculated**.
2. Navigate to the position where you want to place the stake.

The **Go left / Go right** navigation delta is replaced by the calculated horizontal construction offset.

3. Measure and store the point.

The calculated horizontal offset is reported in the **As staked deltas**.

This option is not available if the horizontal offset is applied perpendicular to the string.

Vertical construction offsets

You can define a vertical construction offset where:

- A negative value offsets points vertically down.
- A positive value offsets points vertically up.

The **Vertical Offset** value is not applied to a surface.

Tap  next to the **Vertical offset** field to specify if the offset is to be applied:

- Vertically
- Perpendicular to the element in the cross section before the point being staked

The following diagram shows a **Vertical offset** applied vertically **(1)** and a **Vertical offset** applied perpendicular **(2)** to the previous cross section element **(3)**.

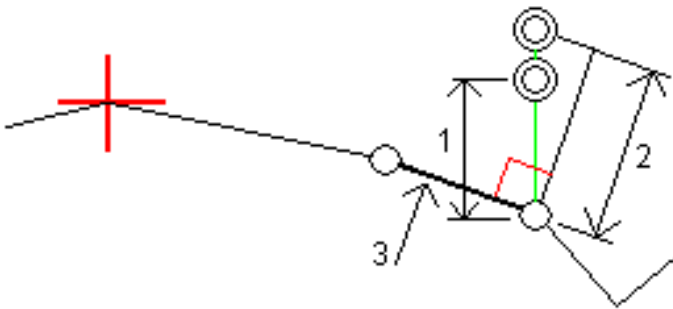

Station construction offsets

You can apply a station construction offset where:

- A positive value offsets the point in the direction of increasing station (Forward).
- A negative value offsets the point in the direction of decreasing station (Backward).

NOTE –

- You cannot apply a station construction offset to a GENIO road 5D string that represents the catch position.
- The station construction offset is applied tangential to the string being staked.

Station construction offsets are useful for positioning sumps along a curved section of road, as shown in the following diagram. Because the sump (1) is typically positioned before the curb (2) and channel is in place, by offsetting the station forward (3) and backward (4) and horizontally left (5) and right (6), the sump can be positioned with the correct orientation.

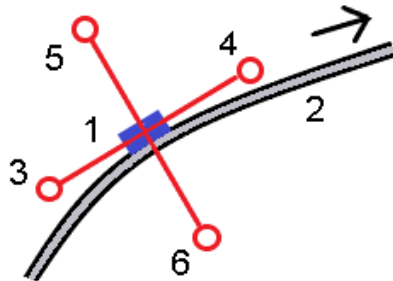

Additional stakeout deltas to a surface



Stakeout typically provides horizontal navigation and cut/fill relative to the road or string you are staking.

In addition you can display cut/fill to a selected surface. The surface can be a [topographical surface](#), or it can be any surface in a BIM file.

1. Transfer a surface file to the appropriate [project folder](#) on the controller.
2. Make sure the file containing the surface is visible and selectable in the map.

When staking a topographical surface, your current position, elevation of your current position, the surface elevation, and the distance above (cut) or below (fill) the surface appear in the map screen.

3. In the map, tap the road or string and then tap **Stakeout**.
4. Enable the **Cut/Fill to surface** switch.
 - a. In the **Surface** field, select the surface file from the current project folder. Only surface files that are set to visible or selectable in the **Layer manager** are listed.

Alternatively, in the map select surfaces from BIM files. If you cannot select surfaces in the map, make sure the BIM file is set to selectable in the **Layer manager**. If the **Selection mode** button  on the **BIM** toolbar is button is yellow , tap it and select **Surface selection - Individual faces** mode.

NOTE – You can select **Surface selection - Whole object** mode, but when using **Whole object** mode the software selects both the top and bottom surface and calculates the cut/fill to whichever surface you are closest to.

The **Surface** field indicates the number of surfaces you have selected in the map.

To select a different surface from the map, double-tap in the map to clear the current selection and then select the new surface.

- b. If required, in the **Offset to surface** field, specify an offset to the surface. Tap  to select whether the offset is to be applied vertical or perpendicular to the surface.
 - c. To show the distance to the surface in the stakeout navigation screen, tap **Options**. In the **Deltas** group box, tap **Edit** and select the **V. Dist surface at current position** or the **Perp. Dist to surface at current position** delta. Tap **Accept**.
5. Stake out the road as usual.

NOTE – When staking **To the primary string**, **To the road**, or **To the string**, the cut/fill is to the surface at your current position. When staking **To a station on a string**, the cut/fill displayed is the cut/fill to the surface at the selected station (including when using construction offsets).

When viewing the cross section, the surface is displayed at your current position as a green line. A circle on the surface indicates your position projected vertically to the surface. If the BIM model selection mode is **Surface selection - Whole object**, the cross section displays both the top and bottom surface. A circle on the surface indicates your position projected vertically to the surface.

TIP –

- To check layer thickness when constructing a road, define a surface for the previous layer and then when staking out the current layer, tap **Options** and in the **Deltas** group box, tap **Edit** and select one of the **V.Dist surface** deltas.
- To change the selected surface, tap **Esc** to return to the stakeout selection screen and select a different surface file. To select a different surface from the map, double-tap in the map to clear the current selection and then select the new surface.

Catch point

NOTE – The catch point applies only when staking from a **road design file**. A catch point does not apply when staking **Strings and surfaces**.

The catch point is the point where the design side slope intersects with the ground.

The actual intersection position of the side slope with the existing ground surface – the catch point – is determined iteratively (by repetition). The software calculates the intersection of a horizontal plane passing through the current position, and either the cut or fill side slope, as shown in the following diagram, where x_n is the **Go Right/Left** value.

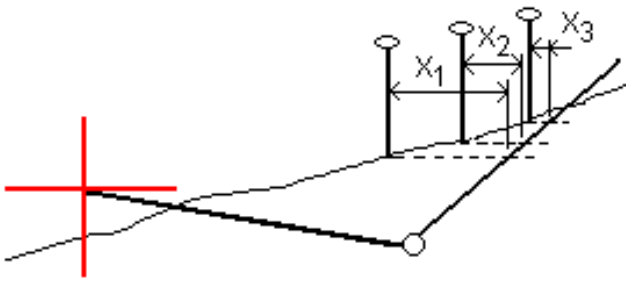

The plan view shows the calculated catch position. The calculated slope value (in blue) and the design slope value appears at the top of the screen.

The cross section is displayed looking in the direction of increasing station. Your current position and the calculated target are indicated. A line is drawn (in blue) from the hinge position to your current position to indicate the calculated slope.

Green lines indicate if the catch point has construction offsets specified. The smaller single circle indicates the calculated catch position and the double circle indicates the selected position adjusted for the specified construction offset(s). The construction offsets appear only after you have applied them.

NOTE - For side slope offsets where the slope changes between templates, the software calculates the side slope for intermediate stations by interpolating the slope value.

Catch point staked deltas

To view the **Catch point deltas report** screen, tap **Report** in the **Confirm staked deltas** screen or **Review job** screen.

The horizontal and vertical distances from the catch point to each string are shown, up to and including the horizontal alignment. If the template includes a cut ditch, the report includes the hinge position at the toe of the cut slope. The reported values exclude any construction offset specified.

See the diagram below:

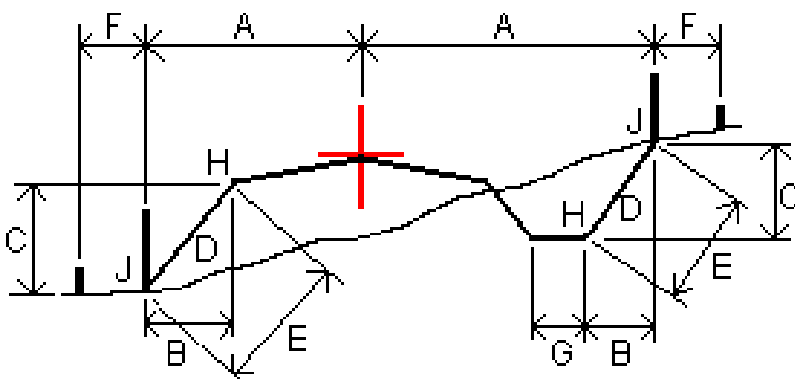

Where:

A	=	Distance to horizontal alignment
B	=	Horizontal distance to hinge point
C	=	Vertical distance to hinge point
D	=	Slope
E	=	Slope distance to hinge point
F	=	Horizontal construction offset
G	=	Ditch offset
H	=	Hinge point
J	=	Catch point

NOTE -

- When you stake a fill side slope with a subgrade, the as staked deltas include the distance from the catch to the intersection of the subgrade with the side slope.
- The value in the **S.Dist to hinge + Constr off** field includes any construction offset values specified and reports the slope distance from the hinge to the as-staked position. The value is null (?) if there is no horizontal construction offset specified or the horizontal construction offset is applied horizontally.

Side slopes

In some situations, you may need to temporarily add or edit the side slope. The side slope, and any edits to the side slope, are discarded after a position is measured or when you exit the stakeout screen.

NOTE - Side slopes can be used when staking from a **road design file**. Side slopes cannot be used when staking **Strings and surfaces**.

Adding a side slope

You can add a side slope when staking a station on a string or measuring your position relative to a string. The current string is, by default, the hinge string but you can [select a different string as the hinge string](#) if required. You cannot add a side slope to the alignment.

1. At the stakeout screen, tap and hold in the map or cross section view and select **Add side slope**.
2. Complete the details defining the side slope.

NOTE – Adding a side slope at stakeout is available only for an RXL road. However, when defining a GENIO road you can add a new string and then edit its type to be an **Interface 5D string**, which effectively adds a side slope.

Editing a side slope

If the design cut or fill slope value or the cut ditch width value is not applicable, overwrite the value with a new one.

1. At the stakeout screen, tap and hold in the map or cross section view and select **Edit side slope**.
2. Complete the details defining the side slope.

In some situations, it may be preferable to adjust the cut or fill slope value to the value defined by the slope from the current string to the next string or from the previous string to the current string. In either the **Cut slope** field or the **Fill slope** field, select **Slope to next string** or **Slope from previous string**. The **Slope** field updates with the appropriate slope value.

The [example below](#) shows where you might select the **Slope to next string** or **Slope from previous string** option for a cut slope. A similar approach can be used for a fill slope.

NOTE – The next or previous string slope options are available:

- Only if a next or previous string exists.
- In the **Cut slope** field, the options are available only if the next or previous slope values are positive, that is, if they define a cut slope.
- In the **Fill slope** field, the options are available only if the next or previous slope values are negative, that is, if they define a fill slope.

Sometimes, particularly for LandXML road files, the side slope may specify only one slope value, where the other is null (?). If, when staking a side slope, the design and calculated side slope values at the top of the navigation screen are null, this indicates that the undefined slope value is required to stake the catch. Use the **Edit side slope** option to specify the slope value to enable the catch to be staked.

You can also:

- change the string name.
- [select a different string as the hinge string](#), if required.

A side slope is shown in red if edited.

The [diagram](#) below shows a typical example of where you might use these options.

Selecting a different string as the hinge string

1. At the stakeout screen, tap and hold in the plan or cross section view and select **Edit Side Slope**.
2. From the **Hinge string** field tap the arrow and then select a string by one of these methods:

- Tap a string on the screen
- If appropriate for your controller, use the left/right arrow keys
- Tap and hold on the screen and select the string from the list

The current hinge string is shown as a solid blue circle.

Example – select hinge string and edit side slope

The diagram below shows a typical example of where you might select a different string as the hinge string. In this example, the original design with the hinge at string **C** is in fill, resulting in an unwanted fill zone **(1)**. By selecting string **B** as the hinge string, the new design is now in cut and the unwanted fill zone is avoided.

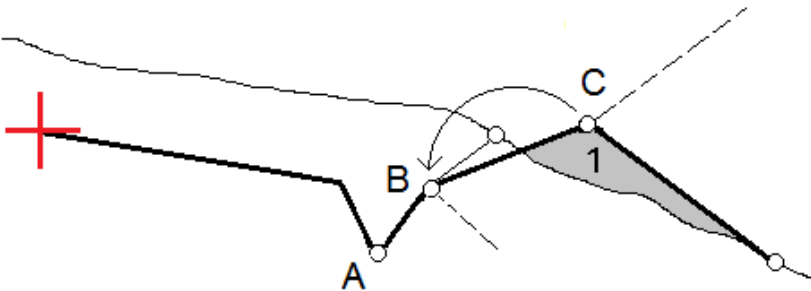

With string **B** selected as the hinge string, the cut slope can be defined by either retaining the design slope value or keying in another value. Alternatively, the cut slope can be defined by selecting one of the following:

- **Slope from previous string** option to define the cut slope as the slope from the previous string **A** to the new hinge string **B**, resulting in a catch position at **(2)**.
- **Slope to next string** option to define the cut slope as the slope from the new hinge string **B** to the next string **C**, resulting in a catch position at **(3)**.

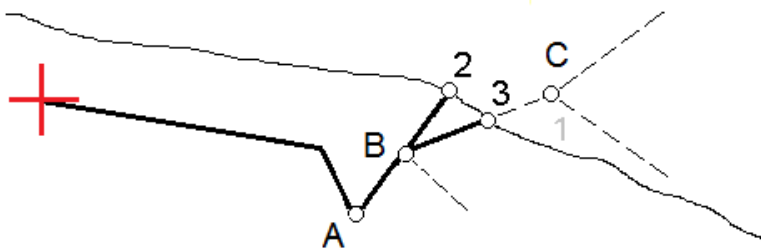

Cross slopes

Define a cross slope when you need to confirm the construction of a road surface – typically the carriageway.

NOTE –

- Cross slopes can be used when staking from a **road design file**. Cross slopes cannot be used when staking **Strings and surfaces**.
- A cross slope must be defined in the cross section view.
- A cross slope cannot be defined when measuring your position relative to the road or when staking a side slope.

When using a cross slope, typically a wire **(1)** is stretched from one side of the road to the other fixed at position **(2)** on each stake. The wire is then checked to see that it lies on the formed road surface **(4)**. The process is then repeated for the other side of the road by fixing the wire to the stakes at position **(3)**. The cross slope can be offset vertically so that the wire is above the surface making it easier to confirm the construction. If the cross slope is offset, the measured distance from the wire to the surface should be consistent. The cross slope option reports the deltas, enabling the stake to be marked up with positions **(2)** and **(3)**.

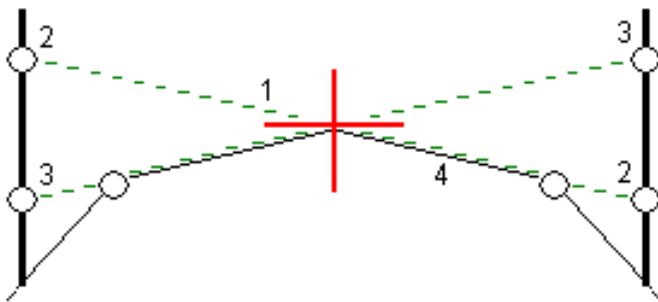

To define a cross slope

1. From the cross section view, define a horizontal construction offset, typically at **Slope previous**, and enter a vertical offset if required.

The smaller single circle **(8)** indicates the selected position and the double circle **(6)** indicates the selected position adjusted for the specified construction offsets. The construction offsets appear as green lines **(7)**.

2. From the plan or cross section view, tap **Cross slope** and follow the on-screen prompts to define the cross slope.

The selected line **(1)** appears as a bold green line. A dashed green line **(2)** extends from the selected line to intersect with a vertical line **(4)** at the target stake **(3)**.

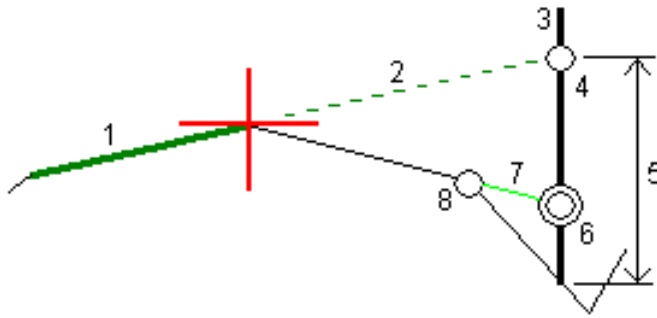

NOTE – You cannot define a cross slope by selecting a line that defines a side slope.

3. Tap **Accept**.
4. Tap **Start**.
5. Navigate to the target and then stake the position.
6. Use the **V.Distance. cross slope** value (**5**) to mark the stake with the second position.

To stop using the cross slope

To de-activate the cross slope function, tap **Cross slope** and tap **Clear** and then tap **Close**.

Subgrades

Define a subgrade when the cross section represents the finished road surface and you need to stake the points defining other surfaces in the road – typically the subgrade.

NOTE –

- Subgrades can be used when staking from a **road design file**. Subgrades cannot be used when staking **Strings and surfaces**.
- You cannot define a subgrade from the **Stakeout method** screen or when measuring your position relative to a road or a string.

Subgrade points are computed by creating a temporary line that is parallel to, and offset from, a line between two strings in the cross section. The points can then be selected for stakeout:

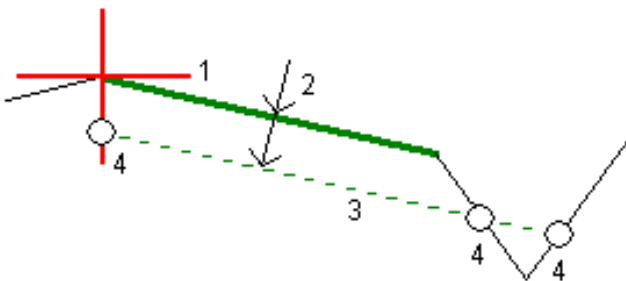

To define a subgrade

1. From the plan or cross section view, tap **Subgrade** and follow the on-screen prompts to define the subgrade.

The selected line **(1)** appears as a bold green line. The depth to subgrade **(2)** is from the selected line to the subgrade surface. A dashed green line **(3)** extends to intersect with all encountered lines in the cross section. If no intersection(s) are found, computed points are created at the same start and end offsets as that of the selected line. The single circles **(4)** indicate the computed positions.

NOTE – You cannot define a subgrade by selecting a line that defines a side slope.

2. Tap **Accept**.
3. Tap the position that you want to stake.
4. Navigate to the target and then stake the position.

To stop using the subgrade

To de-activate the subgrade function, tap **Subgrade** and tap **Clear** and then tap **Close**.

Precise elevations

If you are using a GNSS receiver for stakeout, then you don't need to maintain line of sight to a total station. Sometimes, however, you need to use a total station for better elevation control. In Trimble Access Roads you can enable the **Precise elevation** option to get the best of both worlds: set up an integrated survey and use the GNSS for horizontal positioning and use the total station for vertical positioning.

Because you don't need the total station for horizontal positioning you can set it up on a high point with good visibility (no horizontal coordinates are needed) and use the **Station elevation** feature to tie into known point(s) to set the elevation control.

When using **Precise elevation**, the software provides horizontal navigation based on GNSS, and vertical navigation from the total station. When you store the staked point, three point records are stored: a GNSS position, a total station position, and a combined position.



TIP – For an overview of setting up precise elevation and using it to stake out a road, watch the [Integrated surveying with precise elevation](#) video on the [Trimble Access YouTube channel](#).

To configure the software to use precise elevation

1. In the integrated survey style you will use, select the **Precise elevation** check box.
2. To use precise elevations, you must switch to the Roads app. To switch between applications, tap  and tap the name of the app you are currently using, and then select the application to switch to.

To set up the conventional instrument

TIP – To set up the conventional instrument, position the instrument in a location with good visibility and safe from machinery. The elevation is determined by one or more **Station elevation** measurements to point(s) with a known elevation. You can set up the robotic total station on a known control point, but this is not required.

1. Position the conventional survey instrument and then tap  and select **Stakeout / <integrated style name> / Station elevation**.
2. The RTK survey starts. Once the RTK survey has initialized, you can begin the station setup for the conventional survey.
3. Set the corrections associated with the instrument.

If the **Corrections** form does not appear, tap **Options** from the **Station setup** screen to set the corrections. To make the **Corrections** form appear on startup, select the **Show corrections on startup** option.

4. Tap **Accept**.
5. If required, enter the **Instrument point name**, **Code**, and **Instrument height**. If the instrument is not set up on a known point with a known elevation, accept the default point name and 0.000 instrument height.
6. Tap **Accept**.
7. Enter the point name, code, and target details for the point with the known elevation.

TIP – To select a point already in the job, such as a control point, tap ► next to the **Point name** field. Alternatively, you can key in a point. The point needs only a name and an elevation – horizontal coordinates are not required.

CAUTION – If you are using IMU tilt compensation for the RTK part of the integrated survey, the tilt compensation is not applied to the conventional observations. Be sure to level the pole when the **Precise elevation** option is enabled when surveying a road using the Roads software, and when using conventional total station measurements.

8. Position the prism on the point with the known elevation and tap **Measure**. The elevation value is transferred to the instrument point. Once the measurement is stored, the **Point residuals** appear.
9. From the **Point residuals** screen, tap one of the following softkeys:
 - **+ Point**, to observe additional known points
 - **Details**, to view or edit point details
 - **Use**, to enable or disable a point
10. To view the station elevation result, tap **Results** in the **Point residuals** screen. To accept the result, tap **Store**.

To start staking out

1. In the map, tap the road and then tap **Stakeout**.

The software shows a message indicating that **Road stakeout precise elevation is enabled**.

If you are using a GNSS receiver with IMU tilt compensation, the message warns that you must level the pole for as-staked observations, because tilt compensation is not applied to the conventional observations.

2. Tap **OK** to dismiss the message.
3. The road is ready to stake, using your preferred stakeout method.

During stakeout, the software provides horizontal navigation based on GNSS, and vertical navigation from the total station.

When you store the staked point, three point records are stored: a GNSS position, a total station position, and a combined position.

NOTE - If the robotic total station cannot measure to the target, the cut/fill and vertical distance values are shown as "?".

Reports

Use the **Reports** function in the software to generate reports from survey data. Use these reports to check data in the field, or to transfer data from the field to your client or to the office for further processing with office software.

Roads stakeout reports

TIP – To display the **Confirm staked deltas** screen before you store a point, select the **View before storage** check box in the **Stakeout options** screen and then select the required format in the **Stakeout deltas format** field.



If you chose to install a **Language and Help Files** language pack when you installed the Trimble Access software, stakeout report formats are installed to the controller in the language of your choice. If you did not choose to install a language pack you can install it at any time by running Trimble Installation Manager.

The following stakeout report formats are installed with Trimble Access Roads:

- **Road – Catch + offsets**
Provides details of all the standard road staked deltas plus a list of the horizontal and vertical distances to each of the cross-section positions from the staked offset position. The reported horizontal and vertical distances include the applied horizontal and vertical construction offsets.
- **Road – Stake markup**
Provides a simplified stakeout display that presents the vertical distance (cut/fill) to the road design position. Appropriate station and offset values and cross-section details (in the case of catch point staking) are reported, based on the road stakeout method.
- **Road – XS details**
Provides all the standard road staked deltas details as well as a list of the cross-section elements (left and right) that define the design cross-section at the selected station.

Stylesheets for additional roading reports can be downloaded from the [Software and utilities page](#) of the Trimble Field Systems Help Portal.

To generate a report

1. Open the job that contains the data to export.
2. Tap  and select **Report**.
3. In the **File format** field, specify the type of file to create.
4. Tap  to open the **Select folder** screen.
 - a. To create a new folder, select the folder where you want to store the new folder and then tap .
 - b. Select the folder you want to store the exported data to and then tap **Accept**.
5. Enter a filename.

By default, the **File name** field shows the name of the current job. The filename extension is defined in the XSLT stylesheet. Change the file name and extension as required.
6. If more fields are displayed, complete them.

You can use the XSLT stylesheets to generate files and reports based on parameters that you define. For example, when generating a Stakeout report, the **Stakeout horizontal tolerance** and the **Stakeout vertical tolerance** fields define acceptable stakeout tolerances. When generating the report you can stipulate the tolerances, then any stakeout delta greater than the defined tolerances appears in color in the generated report.
7. To automatically view the file after you create it, select the **View created file** check box.
8. To create the file, tap **Accept**.

Alternatively, export the job as a JobXML file and then use the **File and Report Generator utility** to create the report from the exported JobXML file, using the required XSLT stylesheet as the output format.

The File and Report Generator utility can be downloaded from the [Software and utilities page](#) of the Trimble Field Systems Help Portal.

Legal information

Trimble Inc.

www.trimble.com/en/legal

Copyright and trademarks

© 2025, Trimble Inc. All rights reserved.

Trimble, the Globe and Triangle logo, Autolock, CenterPoint, FOCUS, Geodimeter, GPS Pathfinder, GPS Total Station, OmniSTAR, ProPoint, RealWorks, Spectra, Terramodel, Tracklight, Trimble Connect, Trimble RTX, and xFill are trademarks of Trimble Inc. registered in the United States and in other countries.

Access, Catalyst, FastStatic, FineLock, GeoLock, GX, IonoGuard, ProPoint, RoadLink, TerraFlex, TIP, Trimble Inertial Platform, Trimble Geomatics Office, Trimble Link, Trimble Survey Controller, Trimble Total Control, TRIMMARK, VISION, VRS, VRS Now, VX, and Zephyr are trademarks of Trimble Inc.

Microsoft, Excel, Internet Explorer, and Windows are either registered trademarks or trademarks of Microsoft Corporation in the United States and/or other countries.

Google and Android are trademarks of Google LLC.

The Bluetooth word mark and logos are owned by the Bluetooth SIG, Inc. and any use of such marks by Trimble Inc. is under license.

Wi-Fi and Wi-Fi HaLow are either registered trademarks or trademarks of the Wi-Fi Alliance.

All other trademarks are the property of their respective owners.

This software is based in part on the work of the Independent JPEG Group, derived from the RSA Data Security, Inc, MD5 Message-Digest Algorithm.

This product includes software developed by the OpenSSL Project for use in the OpenSSL Toolkit (www.openssl.org/).

Trimble Access includes a number of open source libraries.

For more information, see [Open source libraries used by Trimble Access](#).

The Trimble Coordinate System Database provided with the Trimble Access software uses data from a number of third parties.

For more information, see [Trimble Coordinate System Database Open Source Attribution](#).

The Trimble Maps service provided with the Trimble Access software uses data from a number of third parties. For more information, see [Trimble Maps Copyrights](#).

For Trimble General Product Terms, go to www.trimble.com/en/legal.